

## Axles 111-172

<b>Axles</b> .....	<b>112-118</b>
<b>Weldments</b> .....	<b>113</b>
<b>Hardware</b> .....	<b>115-118</b>
-Dust Shields .....	<b>115</b>
-Spindle Nuts .....	<b>116-117</b>
-Spindle Washers .....	<b>118</b>
<b>Brakes</b> .....	<b>119-146</b>
<b>Air Disc Brake</b> .....	<b>119-122</b>
-Chambers .....	<b>119</b>
-Pads .....	<b>120</b>
-Calipers .....	<b>121</b>
-Hubs & Rotors .....	<b>121-122</b>
<b>Brake Chambers</b> .....	<b>123-129</b>
-Piggybacks .....	<b>123</b>
-Service Brake Chambers	<b>123</b>
-Spring Brake Chambers	<b>124-125</b>
-Accessories .....	<b>126-129</b>
<b>Brake Shoes</b> .....	<b>130-146</b>
-Hardware Kits .....	<b>130-136</b>
-Shoes .....	<b>137-146</b>
<b>Camshafts</b> .....	<b>147-150</b>
<b>Repair Kits</b> .....	<b>151-162</b>
<b>Individual Components</b> .	<b>162-165</b>
-Brackets .....	<b>162-163</b>
-Bushings .....	<b>164</b>
-Seals .....	<b>165</b>
-Snap Rings .....	<b>165</b>
-Washers .....	<b>165</b>
<b>Slack Adjusters</b> .....	<b>166-172</b>
<b>Automatic</b> .....	<b>166-170</b>
<b>Manual</b> .....	<b>170</b>
<b>Accessories</b> .....	<b>171-172</b>

# Axles, Brakes & Hdw

## Axles

AXL

Axles

### TN Spindle

	Track	Wall Thickness	Cam Length	Brake Type
MTRTN-4671-LR-1150			17-3/8 in.	
MTRTN-4671-LR-1250	71-1/2 in.	1/2 in.	20-15/32 in.	Q+
PROAXL71NME67			20-13/32 in.	
PROAXL71NSE67			17-5/16 in.	
MTRTN-4671-LR-7150	77-1/2 in.	1/2 in.	17-3/8 in.	Q+
MTRTN-4671-LR-7250			20-15/32 in.	



(PROAXL71NME67)

### TP Spindle

	Track	Wall Thickness	Cam Length	Brake Type
MTRTP-8671-LR-1350	71-1/2 in.	5/8 in.	24-9/64 in.	Q+
MTRTP-8671-LM-7350	77-1/2 in.	5/8 in.	24-9/64 in.	Q+ & Tire Inflation System
PROAXL77PHLE67			24-1/16 in.	Q+



(MTRTP-8671-LM-7350)

### Quick Reference Pro-Par Axle Part Numbers

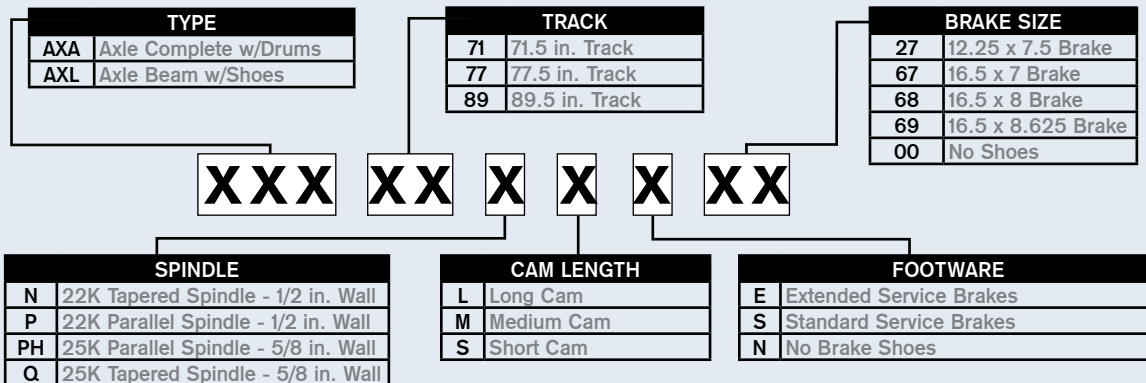

## Axles

### TQ Spindle

	Track	Wall Thickness	Cam Length	Brake Type
<b>MTRTQ-4671-LR-1350</b>	71-1/2 in.	5/8 in.	24-9/64 in.	Q+
<b>PROAXL71QLE67</b>			24-1/16 in.	
<b>MTRTQ-4671-LR-7350</b>	77-1/2 in.	5/8 in.	24-9/64 in.	Q+
<b>PROAXL77QLE67</b>			24-1/16 in.	

## Axle Weldments

	Track	Spindle Type	Wall Thickness	Cam Length	Location	Ride Height	Note
<b>HENHTRAAX.5080</b>							
<b>MTRWP-4671-NS-7101</b>	77-1/2 in.	WP	1/2 in.	17-3/8 in.	Front	16-1/2 in.	RHP-11

## Dressed Axles

	Track	Spindle Type	Cam Length
<b>PROAXA71NME67-001</b>		TN	
<b>PROAXA71QLE67-001</b>	71-1/2 in.	TQ	16-1/2 in.
<b>PROAXA77QLE67-001</b>	77-1/2 in.	TQ	16-1/2 in.

Constructed of high-quality materials and designed for superior reliability. Pro-Par Dressed Axles are assembled by Wabash National, North America's leader in trailer manufacturing and innovation - with over 75,000+ dressed axles produced in 2017.

NOTE: Additional Options Available. Contact Your Aurora Regional Sales Manager for Details.

## Cross Reference & Bearing Guide

### Axles

#### Axle Beam

Refers to axles without camshafts or brake shoes.

#### Axle

Refers to axles with camshafts and brake shoes.

#### Dressed

Refers to axles complete with braking system and wheel-end components. Including hubs, bearings, wheel seals, spindle nuts, drums or rotors, parking brake chambers, automatic slack adjusters, sensor block and hubcaps.

Meritor	Pro-Par	Spindle Type	Bearing Combo (Inner/Outer)
MTRTN-4671-LR-1250	PROAXL71NME67	TN	HM218248/ HM212049
MTRTN-4671-LR-1150	PROAXL71NSE67		
MTRTN-4671-LR-7150	PROAXL77NSE67		
MTRTQ-4671-LR-1350	PROAXL71QLE67	TQ	HM218248/ HM212049
MTRTQ-4671-LR-1250	PROAXL71QME67		
MTRTQ-4671-LR-7350	PROAXL77QLE67		
MTRTP-8671-LR-1350	PROAXL71PHLE67	TP	HM518445/ HM518445
MTRTP-4671-LR-1150	PROAXL71PSE67		
MTRTP-8671-LR-7350	PROAXL77PHLE67		
MTRTP-4671-LR-7150	PROAXL77PSE67		

# Axles, Brakes & Hdw

AXL

Axles

## Quick Reference

### Meritor Aftermarket Axle Part Numbers

BRAKE DIAMETER	
2	12-1/4 in. (31 cm)
5	15 in. (38 cm) (1)
6	16-1/2 in. (42 cm)
8	18 in. (46 cm)

DESIGN VARIATIONS	
C	Crank
D	Drop
P	Positive Bearing Adjustment (obsolete)
[BLANK]	Straight with Manual Bearing Adjustment

BEAM TYPE	
T	Tubular
R	Rectangular (obsolete)

BRAKE WIDTH	
1	10 in. (25 cm)
6	6 in. (15 cm) (2)
7	7 or 7-1/2 in. (18-19 cm)
8	8-5/8 in. (22 cm)
9	8 in. (20 cm)

MISCELLANEOUS	
0	FMVSS121 Brake Certification (discontinued)
1	Equipped for ABS (7)
6	Wabash MBS2 Prepared

#### BRAKE TYPE - Q = Q CAM BRAKE, L = Q+ CAM BRAKE STANDARD SERVICE AXLES

NA	Same as NR with Sensors, Cable Clips & Tie-Wraps (5)
NR	Aftermarket Service Axle less Brake & less Locator Hole (5)
QR/LR	Aftermarket Q/Q+ Cam Brake Service Axle less Locator Hole (5)
NM	Aftermarket Service Axle, for Meritor Tire Inflation System less Brake, with Airline Hole, PSI Plugs & Stator (5)
QM/LM	Aftermarket Service Axle for Meritor Tire Inflation System with Q/Q+ Brake, Airline Hole, PSI Plugs & stator (4)
RHP / MPA SERVICE AXLES	
NS	Aftermarket RHP/MPA Service Axle with Suspension Seats, less Brakes (5)
OS/LS	Aftermarket RHP/MPA Service Axle with Suspension Seats & Q or Q+ Brakes (4)
NP	Aftermarket RHP/MPA Service Axle with Suspension Seats less Brake, with Airline Hole & PSI Plugs with Stator (5)
QP/LP	Aftermarket RHP/MPA Service Axle with Suspension Seats & Q or Q+ Brakes, Airline Hole and PSI Plugs with Stator (4)

**XX \* X - XXXX - XX - XXXX**

BEAM CAPACITY LB (KG)	
N	22,500 (10,206)
Q	25,000 (11,340)
P	30,000 (13,608)
P	22,500 (10,206)
P	25,000 (11,340)
R	22,500 (10,206)
R	25,000 (11,340)
B	22,500 (10,206)
B	25,000 (11,340)
L	22,500 (10,206)
L	25,000 (11,340)

TRACK	
1	71.5 in. Track
7	77.5 in. Track
8	83.5 in. Track

RHP/MPA SEAT BRACKETS	
0	Less Seat Brackets
1	16-1/2 in. Front RHP/MPA
2	16-1/2 in. Rear RHP/MPA
3	17-1/2 in. Front RHP
4	17-1/2 in. Rear RHP
5	18-1/2 in. Front RHP
6	18-1/2 in. Rear RHP
7	17-1/2 in. - 18-1/2 in. Front MPA
8	17-1/2 in. - 18-1/2 in. Rear MPA

MODIFICATION	
1	Single Wheel
2	Intermodal
3	Bolted on Brakes
4	Standard Wall Thickness
5	MPA38 Only (8)
6	Positive Bearing Adj (obsolete)
8	Heavy Wall Thickness (5/8 in.)
9	Heavy Wall Thickness (3/4 in.)

CAM LENGTH / SPLINE	
0	No Cams
1	Short 28T
2	Intermediate 28T
3	Long 28T
4	Short 10T
5	Intermediate 10T
6	Long 10T

LINING MIX	
0	No Brake
1	R202 (obsolete)
2	R301
3	R201 (obsolete)
4	SOR615
5	MA212
6	MA312

* BEARINGS	
N	HM218248/HM212049
P	HM518445/HM518445
Q	HM218248/HM212049
R	594A/580
B	Unitized Hub & Bearings (discontinued)
L	Unitized Hub & Bearings (discontinued)

NOTES	
The last four digit designations apply to aftermarket axle model numbers only. These designations do not apply to production axle model numbers.	
(1)	Drum or Rotor
(2)	Denotes brake shoe width or pad size
(3)	Service beam only
(4)	Equipped with brake shoes & camshafts
(5)	Equipped with camshafts but no brake shoes
(6)	Not available in crank or drop center axles
(7)	All axles will have ABS blocks installed
(8)	Use standard nomenclature rules for MPA40



**Dust Shields**

**FRUAPA1192-3**



**Fruehauf**

Black 1-Piece with Split

**HENS-28500-1650**



**Hendrickson**

Material: Metal  
Size: 5 in. Round Axle

**HENS-28500-1657**



**Hendrickson**

Material: Metal  
Size: 5-3/4 in. Round Axle

**Dust Shield Clamp Kit**  
**HENS-28501-500**



**Hendrickson**

5.00" Clamp & Hardware Kit

**Dust Shield Clamp Kit**  
**HENS-28501-575**



**Hendrickson**

5.75" Clamp & Hardware Kit

**AXL**  
Axles

**FRUEHAUF**  
**HENDRICKSON**

**Tech Tip**

**Dust Shields**

Dust shields are installed between the rim and the brake disc. The dust shield catches all the dust blown from the brake disc and prevents it from settling on the rims.

## Spindle Nuts

AXL

Axles

	Type	Size	Bearing	Note
<b>MTRR000540</b>	Inner	2-5/8 in. - 16	HM218248/HM218210, Q / N	1227-C-549
<b>MTRR000572</b>	Outer	2-5/8 in. - 16	HM218248/HM218210, Q / N	1227-B-756



(MTRR000540)



(MTRR000572)

Meritor

	Type	Size	Bearing
<b>PROWF5200</b>	Outer	2-5/8 in. - 16	Q / N
<b>PROWF5210</b>	Inner	2-5/8 in. - 16	Q / N



(PROWF5200)



(PROWF5210)

Pro-Par

### Temper-Loc Spindle Nuts

	Size	Bearing	Application
<b>MTRMER614723</b>	3-31/64 in. - 12	HM518445/HM518410	TP Trailer
<b>MTRMER614743</b>	2-5/8 in. - 16	HM212049/HM212011	TN Trailer
<b>MTRMER614973</b>	3-1/4 in. - 12	HM580/HM572	R Dive

Temper-Loc precision single-locking nut system provides bearing adjustment with pinpoint accuracy. The nut system sets optimal wheel-end preload maximizing tire life and vehicle uptime.



Meritor

### Retainer Ring

- MTRMER644723**
- MTRMER644743**
- MTRMER644973**

### PRO-TORQ Spindle Nuts

	Size	Bearing	Application
<b>STE447-4723</b>	3-31/64 in. - 12	HM518445/HM518410	Pro-Par, Meritor TP, Hendrickson HP
<b>STE447-4743</b>	2-5/8 in. - 16	HM212049/HM212011	Dana, Eaton, Meritor RL, RQ, TK, TN, TQ, Hendrickson HN
<b>STE449-4973</b>	3-1/4 in. - 12	HM518445/HM518410	Dana Est-230-P, Eaton-22, Meritor TR

Increase tire life and reduce premature wheel seal failure with the proven performance of the Pro-Torq® axle spindle nut. With back off increments down to 0.001 inch and exacting cup and cone alignment on the spindle.



Stemco

### Keeper

- STE450-4723**
- STE450-4743**
- STE450-4973**



## Spindle Nuts

**MTR21225405**

Meritor

For Axles: LM / TN

**MTRKIT-8094**

Meritor

For Axles: TL

**MTRKITSTNEW**

Meritor

For Axles: Meritor RQ, TK, TN, TQ  
 Bearing: HM218248/HM218210 Inner  
 HM212049/HM212011 Outer

**MTRKITSTPN**

Meritor

For Axles: Meritor TP  
 Bearing: HM518445

**PROAXL-NUTKIT**

Pro-Par

For Axles: Meritor RQ, TK, TN, TQ  
 Bearing: HM218248/HM218210 Inner  
 HM212049/HM212011 Outer

## More Information

### Pro-Par Spindle Nuts & Washers

Nut		Spindle	Washer	Lock Washer	Tab Lock	Cotter Pin
PROWF2296	Outer	FD, FE, FF	PROWF2298	PROWF2297		
PROWF2299	Inner	FD, FE, FF	PROWF2298	PROWF2297		
PROWF2303	Inner	TP, TR		PROWF2301/PROWF2304	PROWF2302	
PROWF2305	Outer	TP, TR		PROWF2301/PROWF2304	PROWF2302	
PROWF5200	Outer	TN/TQ		PROWF5300/PROWF5300S	PROWF5660	
PROWF5210	Inner	TN/TQ		PROWF5300/PROWF5300S	PROWF5660	
PROWF5401		Fruehauf	PROWF5402			PROWF5403





### Spindle Washers

AXL

Axles

	Type	Thickness	Inner Diameter	Outer Diameter	Cross Reference
<b>MTR21225514</b>	Tab Lock				
<b>MTRR000573</b>	Lock	1/4 in.	2-41/64 in.	3-15/16 in.	
<b>PROWF2302</b>	Tab Lock	3/64 in.	3-5/16 in.	4.00 in.	
<b>PROWF5660</b>	Tab Lock	1/16 in.	2-41/64 in.	4-1/32 in.	R002237
<b>PROWF5300S</b>	Lock	1/4 in.	2-41/64 in.	3-7/8 in.	
<b>PROWF5300</b>	Lock	1/4 in.	2-41/64 in.	3-15/16 in.	R000573



(MTR21225514)



(MTRR000573)



(PROWF2302)



(PROWF5660)



(PROWF5300S)



(PROWF5300)

## There is a Difference | BRAKE CHAMBERS

### RANGER BRAKE

**pro-par**  
**PROBC-3030C**  
Size: 3030  
Standard Stroke  
Round Ports



**pro-par**  
**PROBC-3030**  
Size: 3030  
Standard Stroke  
Round Ports



**ALSO AVAILABLE**  
**3" Long Stroke**  
Square Ports  
**PROBC-3030LS**

**pro-par**  
**PROBC-18D**  
Size: 18  
Standard Stroke  
Round Ports



**pro-par**  
**PROBC-1824D**  
Size: 18  
Standard Stroke  
Round Ports

*The Future is Here*  
**AIR DISC BRAKES**

**ALSO AVAILABLE:**  
PROBC-16D | PROBC-1624D  
PROBC-18D | PROBC-1824D  
PROBC-20D | PROBC-2024D  
PROBC-24D | PROBC-2424D  
**Standard Stroke 2.5"**

**RANGER**  
**CTS-3030**  
Size: 3030  
Standard Stroke  
Round Ports



**ALSO AVAILABLE**  
**3" Long Stroke**  
Square Ports  
**CTS-3030LS**

**pro-par**  
**PROBCP-3030K**  
Size: 3030  
Standard Stroke  
Round Ports



**pro-par**  
**PROBCP-3030K**  
Size: 3030  
3" Long Stroke  
Square Ports





## Air Disc Brakes

### Chambers

#### Type 16/24

	Stroke	Notes
<b>HOL04454109864</b>	2-1/2 in.	Includes Tubes
<b>HOL04454115860</b>	2-1/2 in.	
<b>PROBC-1624D</b>	2-1/2 in.	



(HOL0445109864)



(HOL0445115860)



(PROBC-1624D)

#### Type 18/24

	Stroke	Location	Notes
<b>BENK132352</b>	2-1/4 in.		Bendix EverSure; 3/8 in. - 18 NPTF Ports
<b>BENK25670</b>	2-1/2 in.		NG-3 Piston Style; 3/8 in. - 18 NPTF Ports
<b>HENS-34446-L</b>	2-1/2 in.	Left Hand	MAXX22T
<b>HENS-34446-R</b>	2-1/2 in.	Right Hand	MAXX22T
<b>HENS-34446-U</b>	2-1/2 in.	Unhanded	MAXX22T
<b>PROBC-1824D</b>	2-1/2 in.		



(BENK132352)



(BENK025670)



(HENS-34446-L/  
HENS-34446-R)



(HENS-34446-U)



(PROBC-1824D)

#### Type 20/24

	Stroke	Location	Notes
<b>HENS-34421-L</b>	2-1/2 in.	Left Hand	WABCO
<b>HENS-34421-R</b>	2-1/2 in.	Right Hand	WABCO
<b>PROBC-2024D</b>	2-1/2 in.		



(HENS-34421-L/  
HENS-34421-R)



(PROBC-2024D)

AXL

Brakes



**Air Disc Brakes**

**Pads**

**AXL**

**Brakes**



Bendix

**BENK070796**



ADB22X; SK-7

Hendrickson

**HENS-35303-1**



MAXX22T

SAF Holland

**HOL03057008500**



Knorr SK7

Pro-Par

**PROADP1311**



Meritor EX225HMCI

Pro-Par

**PROADP1369**



Knorr SK7

Pro-Par

**PROADP1370**



Meritor EXL2

Pro-Par

**PROADP1777**



Wabco Pan 22

Pro-Par

**PROADP1777-1**



Hendrickson Pan 22

Brakes

**Air Disc Brakes**

**Calipers**

**BEN802985**



**Bendix**  
ADB22X

Location	
Left Hand	<b>HENS-35303-7</b>
Right Hand	<b>HENS-35303-8</b>



**Hendrickson**  
MAXX22T

**HENS-35303-9**



**Hendrickson**  
MAXX22T

**Rotor**  
**BEN802569**



**Bendix**  
ADB22X  
No Offset, Heavy-Duty Splined Disc Kit

**Hubs & Rotors**  
**Rotor**  
**CMT10018609**



**ConMet**  
For: TN ADB

**Rotor**  
**CMT10020682**



**ConMet**  
For: FF, FL, & R

**Hub Assembly**  
**CMT10083512**



**ConMet**  
TP Trailer HP10 ABS

AXL

Brakes



**Air Disc Brakes**

AXL

Brakes

**Hubs & Rotors**

**Hub Assembly**  
HOL2073190000100



SAF Holland

Long Studs

**Accessories**

**Dust Shield Kit**  
HENS-28570-4357



Hendrickson

Size: 5-3/4 in.  
Clamp On, 430MM Rotor

**Dust Shield**  
HENS-35720-4415



Hendrickson

Size: 5-3/4 in.  
Bolt-On, 415MM Rotor

**Bolt Kit**  
HENS-33649-5



Hendrickson

MAXX22T Caliper to Torque Plate

**Guide Bolt Kit**  
HENS-35303-4



Hendrickson

MAXX22T Caliper Disc Brake

**Adapter Cap/ Shear**  
HOL03434381600



SAF Holland

HENDRICKSON  
SAF Holland

Brakes

## Brake Chambers

### Piggybacks

#### Type 30/30

	Stroke	Notes
<b>HDXGP3030</b>	2-1/2 in.	Gold Seal piggyback
<b>HDXGP3030K</b>	2-1/2 in.	Gold Seal; Kit - includes piggyback, clamps, diaphragm & hardware
<b>IMXBCP-3030K</b>	2-1/2 in.	Includes piggyback, clamps & diaphragm
<b>MGM3430008</b>	2-1/2 in.	For model TR3030; Includes piggyback, clamps, diaphragm, plug kit, nuts & bolts
<b>PROBCP-3030K</b>	2-1/2 in.	Includes piggyback, clamps & diaphragm
<b>PROBCP-3030K-B</b>	2-1/2 in.	Includes piggyback, clamps & diaphragm; boxed
<b>RNGBPS-3030</b>	2-1/2 in.	Piggyback
<b>RNGBPS-3030K</b>	2-1/2 in.	Kit - includes piggyback, diaphragm, clamps & installation hardware
<b>TSE3030SN2K-3001</b>	2-1/2 in.	Piggyback kit box Omni
<b>MGM3230008</b>	3 in.	For model TR3030LP3; Includes piggyback, clamps, diaphragm, plug kit, nuts & bolts
<b>PROBCP-3030KLS</b>	3 in.	Includes piggyback, clamps & diaphragm
<b>PROBCP-3030KLS-B</b>	3 in.	Includes piggyback, clamps & diaphragm; boxed
<b>RNGBPS-3030KLS</b>	3 in.	Piggyback kit
<b>RNGCPS-3030KLS</b>	3 in.	Piggyback kit
<b>TSE3030SN3K-3003</b>	3 in.	Piggyback kit box Omni



(HDXGP3030K)



(MGM3230008)



(PROBCP-3030K)



(RNGBPS-3030K)

### Service

	Type	Stroke	Notes
<b>NEW905-48-040</b>	9		
<b>RNGBSC-09</b>	9		Pushrod length: 10-3/8 in.
<b>MIDMA36120</b>	12	1-3/4 in.	SC12
<b>RNGBSC-12</b>	12	2-1/4 in.	
<b>MGM1621901</b>	20	2-1/2 in.	CS model; with welded yoke
<b>RNGBSC-20</b>	20	2-1/4 in.	
<b>MIDKN36240</b>	24	2-1/4 in.	SC24
<b>PRE281</b>	24		Pushrod length: 8 in.
<b>RNGBSC-24</b>	24	2-1/2 in.	
<b>ANCSC30</b>	30	2-1/2 in.	
<b>IMXGTA-BC30</b>	30		
<b>HDXSC30L</b>	30	3 in.	Long stroke
<b>RNGBSC-30</b>	30	2-1/2 in.	



(ANCSC30)



(RNGBSC-30)



(TSE30002SC-C)





# MGM Brakes

A Division of Indian Head Industries, Inc.

Along with chambers equipped with standard 8-inch fully threaded push-rods, MGM Brakes also offers a variety of standard rubber and neoprene diaphragm chambers with welded yokes.

## *Key Benefits of the Welded Yoke*

- Reduces chamber replacement time
- No push-rod cutting required
- Save money - no need to buy separate, expensive yoke
- Retains exact chamber to slack adjuster factory set-up



P/N 3232951  
shown here

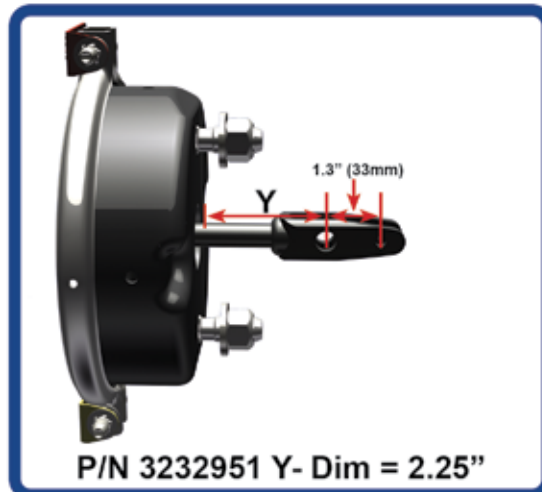

P/N 3232951 Y- Dim = 2.25"

NOTE: Measured from mounting base to center line of large yoke pin with power spring caged.

[www.mgmbrakes.com](http://www.mgmbrakes.com)



## Brake Chambers

### Spring Brake



#### Type 24/24

	Stroke	Push Rod Length
<b>RNGBTS-2424</b>	2-1/2 in.	12-1/2 in.

#### Type 30/30

	Stroke	Push Rod Length	Clevis	Notes
<b>HDXLCP3030S5CW</b>	2-1/2 in.	5-9/16 in.	Yes	Welded Clevis
<b>MGM3430051</b>	2-1/2 in.	8 in., 5/8-18		TR3030
<b>TSE3030TN2-C</b>	2-1/2 in.	8 in.	Yes	Omni Trac
<b>TSE3030TN2-HNTRX-C</b>	2-1/2 in.	8 in.	Yes	Omni
<b>TSE3030TVR2</b>	2-1/2 in.	8 in.		Omni Vct Tandem T-Rex
<b>HDXGC3030</b>	2-1/2 in.	10 in., 5/8-18		Gold Seal
<b>HDXLCP3030</b>	2-1/2 in.	10 in., 5/8-18		Life Seal
<b>RNGBTS-3030</b>	2-1/2 in.	12-1/2 in.**		
<b>RNGBTS-3030-8050</b>	2-1/2 in.	12-1/2 in.**	Yes	Sealed
<b>HOL50866038</b>	2-1/2 in.	12-1/4 in.		
<b>RNGBTS-3030X</b>	2-1/2 in.	12-1/2 in.		Intraax
<b>PROBC-3030</b>	2-1/2 in.	13 in.		
<b>PROBC-3030C</b>	2-1/2 in.	13 in.	Yes	Sealed
<b>RNGBTS-3030-106</b>	2-1/2 in.	13 in.		
<b>RNGCTS-3030</b>	2-1/2 in.	13 in.		Sealed, without clevis
<b>BENNT3030ELS-WC</b>	3	1 in.		S-Cam
<b>HDXGC3030LCW</b>	3	1 in.		Actuator
<b>MGM3230951</b>	3 in.	8 in., 5/8-18		TR3030LP3; Welded yoke; Low profile; Long stroke
<b>MGM3232951</b>	3 in.	8 in., 5/8-18		TR3030LP3HD; HD low profile; Long stroke; Long life
<b>TSE3030TN3-HNTRX-C</b>	3 in.	8 in.	Yes	Omni; Long rod
<b>HDXGC3030L</b>	3 in.	10 in., 5/8-18		Gold Seal; Long stroke
<b>PROBC-3030LS</b>	3 in.	13 in.		Long stroke
<b>RNGCTS-3030LS</b>	3 in.	13 in.		Long stroke
<b>RNGBTS-3030LSX</b>	3 in.	12-1/2 in.		Long stroke; without clevis

## More Information

### Brake Chambers

#### Spring Brake Chambers



Spring brake chambers have two chambers, the service chamber for normal braking functions while the vehicle is in motion and the "parking brake" chamber for parking and emergency brake functions.

#### Piggyback Units



Piggybacks are the parking/emergency chamber portion of a spring brake chamber.

#### Service Chambers



Service chambers fill with air when the vehicle's brake pedal is used, providing stopping power while the vehicle is in motion.

#### Round vs. Square Ports

Standard stroke spring brake chambers have round ports while long stroke spring brake chambers have square ports. (Note: Single chamber service chambers have square ports as well)

AXL

Brakes

HalDEX

RANGER  
Brake Products

MGM  
MGM Brakes

TSE

## Accessories

AXL

Brakes

RANGER Brake Products

HENDRICKSON

MERITOR

Hallex

### Bolts

#### T-Bolt Assembly RNGRB-008

Ranger Brake

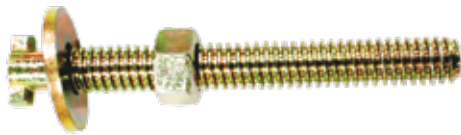

Includes: (1) Washer, (1) T-Bolt, (1) T-Bolt Nut

### Brake Chamber Brackets

#### DANM10WJ227

Hendrickson



### Brake Chamber Brackets

#### HENS-24697

Hendrickson



#### MTR3299A5981

Meritor



### Clamps

#### T30 Clamp Band Kit HDXCB30

Hallex



Includes (2) Clamp Bands, (2) Bolts & (2) Nuts  
Application: Service Chamber

#### IMXGT-5280

Economy



Includes (2) Clamp  
For Type 30 brake chambers

### Clevises & Pins

	Description	Thread	Pin	Length
HENSA-5200-8	Clevis Pin	-	3/8 in.	1/5 in.



Hendrickson

(HENSA-5200-8)

Brakes

## Accessories

### Clevises & Pins

	Description	Thread	Pin	Notes
<b>GUNAS3000</b>	Clevis Assembly	5/8 in. - 18	1/2 in., 1/4 in.	Threaded; Straight
<b>GUNAS3013</b>	Clevis Assembly	5/8 in. - 18	1/2 in., 1/4 in.	Extended Threaded; Straight
<b>GUNAS3018</b>	Clevis Assembly	5/8 in. - 18	1/2 in., 1/4 in.	Extended Threaded; Straight
<b>GUNAS3019</b>	Clevis Assembly	1/2 in.-20 / 5/8 in. - 18	1/2 in., 1/4 in.	Collar Lock; Straight
<b>GUNAS4004</b>	Pin Kit: Includes (6) 1/2 in. clevis pins, (6) 1/4 in. clevis pins & (12) cotter pins			
<b>GUNAS4012</b>	Stainless Steel Pin Kit: Includes (6) 1/2 in. clevis pins, (6) 1/4 in. clevis pins & (12) cotter pins			



(GUNAS3000)



(GUNAS3013)



(GUNAS3018)



(GUNAS3019)



(GUNAS4004)



(GUNAS4012)

Gunite/Accuride

	Description	Thread	Pin	Notes
<b>IMXGT-5400</b>	Clevis Assembly	5/8 in. - 18	1/2 in.	Threaded; KN36470
<b>IMXGT-5400A</b>	Yoke	5/8 in. - 18	-	For 5400 clevis assembly
<b>IMXGT-5400B</b>	Pin	-	1/2 in.	For 5400 clevis assembly
<b>IMXGT-5401</b>	Clevis Assembly	1/2 in. - 20	1/2 in.	Threaded
<b>IMXGT-5402</b>	Clevis Assembly	1/2 in. - 20	5/8 in.	Threaded
<b>IMXGT-5402B</b>	Pin	-	5/8 in.	For 5402 clevis assembly



(IMXGT-5400)



(IMXGT-5400A)



(IMXGT-5400B)



(IMXGT-5401)



(IMXGT-5402B)



(IMXGT-5402)

Economy

	Description	Thread	Pin	Notes
<b>HDXCF1</b>	Clevis Assembly	1/2 in.-20	1/2 in.	Threaded; 9999048; Includes yoke, 1/2 in. clevis pin & cotter pin
<b>MIDKN36470</b>	Clevis Assembly	5/8 in.-18	1/2 in.	Threaded; CF2; Includes yoke, 1/2 in. clevis pin & cotter pin
<b>HDXCP1</b>	Clevis Pin		1/2 in.	19100; Includes 1/2 in. clevis pin & cotter pin
<b>MIDCQ19113</b>	Clevis Pin Kit			Includes (6) 1/2 in. clevis pins, (6) 1/4 in. pivot pins & 12 cotter pins
<b>HDXCF3</b>	Yoke Assembly			
<b>HDX452-10128</b>	Clevis Bushing			



(HDXCF1)



(MIDKN36470)



(HDXCP1)



(MIDCQ19113)



(HDXCF3)



(HDX452-10128)

Hal dex

## Accessories

AXL

Brakes

### Clevises & Pins

	Description	Thread	Pin	Length	Notes
<b>MTR19X1084</b>	Hex Head Clevis Pin		1/2 in.	1-1/2 in.	R801732; 19X60
<b>MTR19X127</b>	Round Head Clevis Pin		1/4 in.	1-3/16 in.	R801730; 19X70
<b>MTRR801730</b>	Round Head Clevis Pin		1/4 in.	1-3/16 in.	
<b>MTRR801732</b>	Hex Head Clevis Pin		1/2 in.	1-1/2 in.	
<b>MTRR810005</b>	Clevis Pin Kit		Includes (1) 19X1084, (1) 19X127 & (2) clips		
<b>MTRR810019</b>	Clevis Assembly	5/8 in. - 18	Straight; Includes clevis, 19X1116 pin, 19X127 pin & cotter pins		



(MTR19X1084)



(MTR19X1116)



(MTR19X127)



(MTRR801732)



(MTRR810005)



(MTRR801730)



(MTRR810019)

### Meritor

	Description	Thread	Pin	Notes
<b>PROBC-CLB01</b>	Clevis Assembly	5/8 in.-18	5/8 in.	Straight; Threaded; Bendix style xRef 107158
<b>PROBC-CLG01</b>	Clevis Assembly	5/8 in.-18	1/2 in.	Straight; Threaded; Gunite style xRef AS3000
<b>PROBC-CLG02</b>	Clevis Assembly	5/8 in.-18	5/8 in.	Collar Lock; Gunite style xRef AS3016
<b>PROBC-CLG03</b>	Clevis Assembly	5/8 in.-18	5/8 in.	Collar Lock; W/collar nuts; Gunite style xRef AS3019
<b>PROBC-CLH01</b>	Clevis Assembly	5/8 in.-18	1/2 in.	Manual; Std; Threaded; Haldex style xRef KN36470
<b>PROBC-CLM01</b>	Clevis Assembly	5/8 in.-18	5/8 in.	Straight; Threaded; Meritor style xRef R810019
<b>PROBC-CLM02</b>	Clevis Assembly	1/2 in.-20	1/2 in.	Straight; Threaded; Meritor style
<b>PROBC-CLPIN1</b>	Clevis Pin		1/2 in.	Greasable
<b>PROBC-CLH03</b>	Clevis Pin		1/2 in.	Length: 1-5/8 in.; With Cotter Pin



(PROBC-CLB01)



(PROBC-CLG01)



(PROBC-CLG02)



(PROBC-CLG03)



(PROBC-CLH01)



(PROBC-CLM01)



(PROBC-CLM02)



(PROBC-CLPIN1)

### Pro-Par

	Description	Thread	Pin	Length	Notes
<b>STEMC8420KTS</b>	Standard ABA Clevis	18		5/8 in.	Includes Pin Kit
<b>STEMC8056KTAS</b>	Pin Kit				



(STEMC8420KTS)



(STEMC8056KTAS)

### Stemco

Brakes

## Accessories

### Diaphragms

	Type	Diameter	Notes
<b>AIRBD9</b>	9	5-1/32 in.	
<b>AIRBD12</b>	12	5-15/32 in.	
<b>AIRBD16</b>	16	6-5/32 in.	
<b>AIRBD20</b>	20	6-17/32 in.	
<b>AIRBD24</b>	24	7 in.	

	Type	Diameter	Notes
<b>AIRBD30</b>	30	7-27/32 in.	
<b>AIRBD303</b>	30	3 in.	Long Stroke



### Ranger Brake

### Plugs

Part Number	Information
<b>BENK034202</b>	
<b>HDXRTP1</b>	Assembly for Gold Seal except XX36
<b>MIDM143982</b>	New Style; RTP2; For Midland Style
<b>MGM9019005P</b>	Weatherseal™; Fits all MGM spring brake chambers except 3036 & 3636 models
<b>RNGRB-30DC</b>	



(BENK034202)



(HDXRTP1)



(MIDM143982)



(MGM9019005P)



(RNGRB-30DC)

### Pushrod Kits

Part Number	Type	Length	Pin
<b>TSEK680-102</b>	Fixed	6.80 in.	1.02 in.
<b>TSEK680-130</b>	Fixed	6.80 in.	1.30 in.
<b>TSEK680-138</b>	Fixed	6.80 in.	1.38 in.
<b>TSEK975</b>	Threaded Rod	9-3/4 in.	



(TSEK680-102)



(TSEK680-130)



(TSEK680-138)



(TSEK975)

### TSE Brakes, Inc.

AXL

Brakes

RANGER  
Brake Products

Halidex

MGM  
MGM Brakes

TSE



## Brake Hardware Kits

### OEM Heavy Duty

#### MTRKIT-8000HD-BULK

Qty	Description
2	Anchor Pin
2	Retainer
2	Spring
1	Spring
2	Pin
2	Bushing
2	Roller



Size: 16-1/2 in.  
Fit: Q & Q+

### Meritor

### Heavy Duty

#### MTRKIT8002HD

Qty	Description
2	Spring
1	Spring



Size: 16-1/2 in.  
Fit: Q

### Meritor

#### MTRKIT-8081

Qty	Description
2	Spring
1	Spring
2	Retainer
2	Pin
2	Bushing
2	Roller
2	Roller



Size: 16-1/2 in.  
Fit: Q

### Meritor

#### MTRMKT4515QHD-B

Qty	Description
2	Anchor Pin
2	Retainer
2	Spring
1	Spring
2	Pin
2	Bushing
2	Roller



Size: 16-1/2 in.  
Fit: Q & Q+

### Meritor





## More Information

### Brake Hardware Kit Cross Reference

Pro-Par	Batco	BWP	Euclid	Leland	Meritor	Midland	Spicer	Sirco
<b>PROWB001A</b>	08-108842/46	-	E3895SHD E4515UHD	K-304 K-304K	KIT 8014HD	C6867 CQ6867	-	QK-2SHD
<b>PROWB002</b>	08-104200	M-K10 M-K99	E1887ASHD E-4311EHD	K-42 K-119	R507002 MKT4311EHDK	C67319 CQ67319	HK24SLM HK24SDLM	EK-1HD
<b>PROWB003</b>	08-109131/35	M-K42	E3710SHD E-4515XHD	K-330	R507010 MKT4515XHDK	C66914 CQ66914	HK34SD	XK-3HD
<b>PROWB004</b>	-	M-K2 M-K7	E1816SHD E-4515PHD	K-45 K-116	R509001 MKT4515PHDK	C67319 CQ67319	HK14SD	TK-4HD
<b>PROWB005</b>	08-111300	M-K77	E5139 E-1308E	K-263	R507004 MKT1308E	C66917 CQ66917	HK54	EF-1
<b>PROWB006</b>	08-116000/04	M-K98	E-9064 E-4702	K-318 K-318K	KIT 8824HD MKT4702KTK	C65642 CQ65642	HK66XLS	RF-5
<b>PROWB008</b>	08-115400/05	-	E-7899	-	R508030	-	-	RF-3A
<b>PROWB009</b>	08-114800	M-K84	E-5481A E-4709ES	K-295	R507057 MKT4709ES	C65481 CQ65481	HK63	ES-1
<b>PROWB015</b>	08-111630/35	M-K106	E-9644	K334 K334K	KIT 8081	CQ66887	HK74XLS	MF-2
<b>PROWB017</b>	08-104700	M-K112	E-10875	K369	R507095	-	HK58XLS	LB-3D
<b>PROWB021</b>	08-107400	M-K12	E-2402HD	K-352	R507015	CQ67398	HK43XLS M12LK101X	LB-1
<b>PROWB027</b>	08-114601	M-K83	E-3782	K-279	R507076	CQ69002	HK47XLS-125	LB-6
<b>PROWB041</b>	08-110702	-	E-6879	K-265	KIT 1125	CQ69003	HK50	RF-2ARK
<b>PROWB046</b>	08-114900	M-K105	E-10244/S E-4709E	K-375	R507064 MKT4709ES2	CQ65477	HK61/SD/XLS	ES-2
<b>PROWB047</b>	08-108830/34	M-K39 M-K72	E2769SHD E4515QHD	K-329 K-332	KIT 8000HD	C66867 CQ66867	HK29XLS	QK-1HD

AXL

Brakes



## Brake Hardware Kits

### Minor Kit

#### PROWB001A

Qty	Description
2	Retainer
2	Spring
1	Heavy Duty Spring
2	Pin
2	Roller

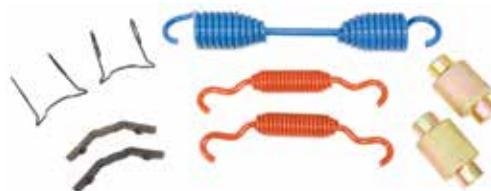

Size: 16-1/2 in.

Fit: Meritor Q, Q+, Dana FC, XLII,  
INTRAAX XLS - FMSI 4707, 4711, 4718,  
4720, 4514g, 4524B, 4551B

Pro-Par

## Brake Hardware Kits

AXL

Brakes

### PROWB002

Qty	Description
2	Roller
2	Spring
2	Roller
1	Heavy Duty Spring



Size: 16-1/2 in.  
Fit: Eaton Single Anchor Pin Brake  
- FMSI 4223A, 4311E, 4317G

### Pro-Par

### Heavy Duty

### PROWB003

Qty	Description
2	Retainer
2	Heavy Duty Spring
2	Anchor Pin
1	Spring
2	Pin
2	Bushing
2	Roller

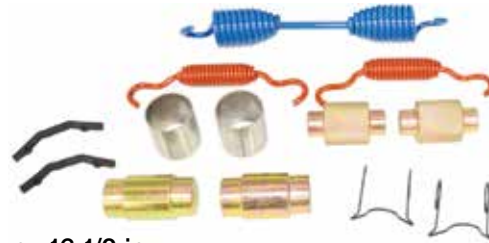

Size: 16-1/2 in.  
Fit: Fruehauf Pro-Par Late Model XEM Brake  
- FMSI 4515X, 4551B

### Pro-Par

### PROWB005

Qty	Description
1	Spring
2	Roller
1	Spring

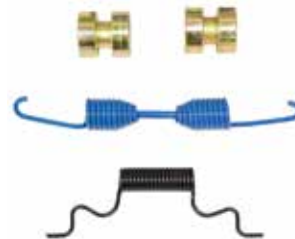

Size: 15 in.  
Fit: Eaton EB & ES Single Anchor Pin Front Brake  
- FMSI 1308E, 1443TT

### Pro-Par

### PROWB006

Qty	Description
2	Anchor Pin
2	Retainer
2	Spring
2	Pin
2	Bushing
2	Roller
1	Spring



Size: 15 in.  
Fit: Meritor Q+ Front & Drive Axle Brake  
- FMSI 4702, 4703, 4704, 4705, 4710

### Pro-Par

## Brake Hardware Kits

AXL

Brakes

### PROWB009

Qty	Description
2	Roller
2	Retainer
1	Spring
2	Spring



Size: 16-1/2 in.  
Fit: Eaton ES Extended Service Brake  
- FMSI 4709, 4719

Pro-Par

### PROWB015

Qty	Description
2	Anchor Pin
2	Retainer
2	Spring
1	Spring
2	Pin
2	Bushing
2	Roller



Size: 16-1/2 in.  
Fit: Mack with Meritor Q Front Brake  
- FMSI 4715, 4720, 4514G, 4524B

Pro-Par

### PROWB017

Qty	Description
2	Anchor Pin
2	Roller Pin
2	Roller
2	Spring
1	Spring
2	Lock
2	Pin
2	Bushing (Stainless)



Size: 12-1/4 in.  
Fit: Dexter PQ Brake  
- FMSI 4591, 4692

Pro-Par

### PROWB026

Qty	Description
2	Anchor Pin
2	Roller Pin
2	Roller Pin
2	Spring
1	Spring
4	Lock
2	Pin
2	Bushing



Size: 12-1/4 in.  
Fit: Meritor "Q" Brake  
- FMSI

Pro-Par

## Brake Hardware Kits

AXL

Brakes

### PROWB046

Qty	Description
2	Roller
2	Retainer
1	Spring
2	Spring



Size: 16-1/2 in.  
Fit: Eaton ES-II Extended Service Brake  
- FMSI 4709E2, 4719, 4725, 4726

### Pro-Par

### Major Kit

### PROWB047

Qty	Description
2	Anchor Pin
2	Retainer
2	Spring
1	Heavy Duty Spring
2	Pin
2	Bushing
2	Roller



Size: 16-1/2 in. x 7 in.  
Fit: Meritor Q & Q+  
- FMSI 4707, 4711, 4715, 4718, 4720, 4514G, 4515Q, 4515E, 4515F5, 4524B, 4551B, 4644B

### Pro-Par

### PROWB050

Qty	Description
4	Spring
2	Spring
2	Pin
2	Roller



Size: 16-1/2 in.  
Fit: "Q", "Q-Plus", "FC", "XLII", "INTRAAX"  
- FMSI

### Pro-Par



**Brake Hardware Accessories**

**AXL**

**Brakes**

**Guide Pin Kit**  
BEN803114



Bendix

**Brake Roller**  
FRU330733



Fruehauf

For Pro-Par Axle

**Spring Pin**  
FRU583015



Fruehauf

For Pro-Par Axle

**Roller Retainer**  
FRUACD2233-1



Fruehauf

For Pro-Par Axle

**Washer**  
FRUACD2813-1



Fruehauf

For Pro-Par Axle

**Return Spring**  
FRUACF3079-1



Fruehauf

For Pro-Par Axle

**Anchor Pin**  
FRUACF3378-1



Fruehauf

For Pro-Par Axle

**Return Spring**  
FRUACF6414-1



Fruehauf

For Pro-Par Axle



**Brake Hardware Accessories**

AXL

Brakes

**Brake Roller**  
MTR1259N274

Meritor



**Roller Retainer**  
SIRB151

Sirco



Application: Use with B586, B611, B911 & B941 Rollers

**Return Spring**  
SIRB349

Sirco



Length: 8-3/8 in.

**Anchor Pin Bushing**  
SIRB888

Sirco



Material: Carbon Steel  
Size: 1-15/32 in.

**Quick Reference**  
Brake Hardware

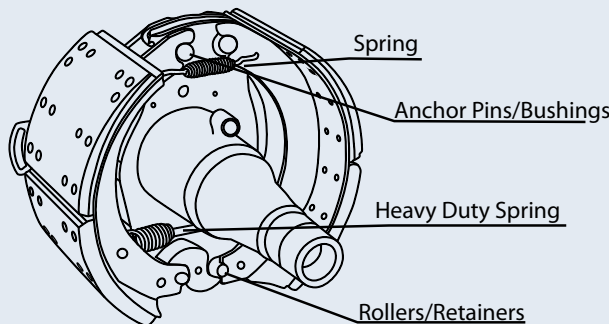



## Brake Shoes

### Relined Brake Shoes

	FMSI#	Lining	Application
<b>ABXE4515QEN</b>	4515Q	6008	16-1/2 in. x 7 in. Meritor Q
<b>ABXE4515XEX</b>	4515X	685	16-1/2 in. x 7 in. Fruehauf XEM 3rd Generation
<b>ABXE4702QEN</b>	4702	6008	15 in. x 4 in. Meritor Q Plus Front
<b>ABXE4702QEX</b>	4702	685	15 in. x 4 in. Meritor Q Plus Front
<b>ABXE4707QEN</b>	4707	6008	16-1/2 in. x 7 in. Meritor Q Plus, Spicer XTRALIFE II & Hend. INTRAAX
<b>ABXE4707QEX</b>	4707	685	16-1/2 in. x 7 in. Meritor Q Plus, Spicer XTRALIFE II & Hend. INTRAAX
<b>ABXE4707QSDA</b>	4707	6098	16-1/2 in. x 7 in. Meritor Q Plus, Spicer XTRALIFE II & Hend. INTRAAX
<b>ABXN4707QEN</b>	4707Q	6008	16-1/2 in. x 7 in. Meritor Q Plus, Spicer XTRALIFE II & Hend. INTRAAX
<b>ABXE4711QRN</b>	4711	6260	16-1/2 in. x 8-5/8 in. Meritor Q Plus, Spicer XTRALIFE II & Hend. INTRAAX
<b>ABXE4720QRN</b>	4720	6260	16-1/2 in. x 5 in. Meritor Q Plus & Spicer XTRALIFE II



(ABXE4720QRN)



(ABXE4707QRN)

ABEX

### Brake Shoe Kit

	FMSI#	Lining	Application
<b>HENS-31962-3</b>	23K		12-1/4 in. x 7-1/2 in. HXS

Hendrickson

### Brake Shoes

	FMSI#	Lining	Application
<b>MTRPSMA2124515Q</b>	4515Q	MA212	16-1/2 in. x 7 in. Meritor Q
<b>MTRKEG4707QP</b>	4707Q	EG	16-1/2 in. x 7 in. Meritor Q+
<b>MTRKMA2124707QP</b>	4707Q	MA212	16-1/2 in. x 7 in. Meritor Q+
<b>MTRPKSMA2124707QP</b>	4707Q	MA212	16-1/2 in. x 7 in. Meritor Q+
<b>MTRPKSMA2124707QPG</b>	4707Q	MA212	16-1/2 in. x 7 in. Meritor Q+
<b>MTRPSMA2124707QP</b>	4707Q	MA212	16-1/2 in. x 7 in. Meritor Q+
<b>MTRSNIMG14711QP</b>	4711Q	MG1	16-1/2 in. x 8-5/8 in. Meritor Q+



(MTRPKSMA2124707QP)



(MTRPSMA2124707QP)

Meritor

### Brake Shoe Kit

	FMSI#	Lining	Application
<b>STEWK4515QCXLBL</b>	4515Q	20K	Premium, Crest XL with B-Lock
<b>STEWKS4707QCXLBL</b>	4707Q	20K	Premium, Crest XL with B-Lock

Stemco

**Brake Shoes**

AXL

Brakes

**12-1/4 in. Web 2**

**FMSI# 4692Q2 - 12-1/4 in. x 7-1/2 in.**

Spicer U

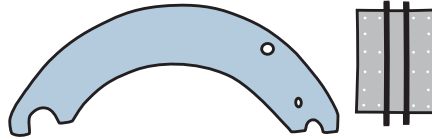

New Brake Shoe

- PROBSN4692Q220STD
- PROBSN4692Q220PR
- PROBSN4692Q223STD
- PROBSN4692Q223PR

New Brake Shoe Kit\*

- PROBKN4692Q220STD
- PROBKN4692Q220PR
- PROBKN4692Q223STD
- PROBKN4692Q223PR

**Hardware Kit**

Trailer Axle  
PROWB027

Relined Brake Shoe

- PROBSE4692Q220STD
- PROBSE4692Q220PR
- PROBSE4692Q223STD
- PROBSE4692Q223PR
- PROBSE4692Q225HDC

Relined Brake Shoe Kit\*

- PROBKE4692Q220STD
- PROBKE4692Q220PR
- PROBKE4692Q223STD
- PROBKE4692Q223PR
- PROBKE4692Q225HDC

Pro-Par

**15 in. Web 1**

**FMSI# 1308E - 15 in. x 4 in.**

Eaton Front

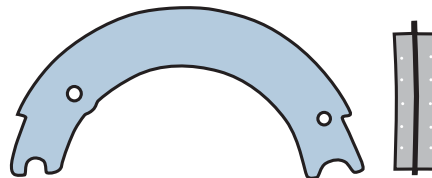

New Brake Shoe

- PROBSN1308E20STD
- PROBSN1308E20PR
- PROBSN1308E23STD
- PROBSN1308E23PR

New Brake Shoe Kit\*

- PROBKN1308E20STD
- PROBKN1308E20PR
- PROBKN1308E23STD
- PROBKN1308E23PR

**Hardware Kit**

Steering Axle  
PROWB005

Relined Brake Shoe

- PROBSE1308E20STD
- PROBSE1308E20PR
- PROBSE1308E23STD
- PROBSE1308E23PR
- PROBSE1308E25HDC

Relined Brake Shoe Kit\*

- PROBKE1308E20STD
- PROBKE1308E20PR
- PROBKE1308E23STD
- PROBKE1308E23PR
- PROBKE1308E25HDC

Pro-Par

Stocking Part Number  
Quote Part Number

\*Each Brake Shoe Kit comes boxed with  
(2) brake shoes and (1) hardware kit.



Brakes

**Brake Shoes**

15 in. Web 1

**FMSI# 1308Q - 15 in. x 4 in.**

Meritor Q Front

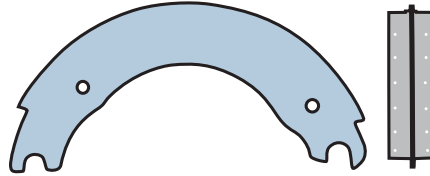

New Brake Shoe

- PROBSN1308Q20STD**
- PROBSN1308Q20PR**
- PROBSN1308Q23STD**
- PROBSN1308Q23PR**

New Brake Shoe Kit\*

- PROBKN1308Q20STD**
- PROBKN1308Q20PR**
- PROBKN1308Q23STD**
- PROBKN1308Q23PR**

**Hardware Kit**

Steering Axle  
**PROWB008**

Steering Axle  
**PROWB039**

Relined Brake Shoe

- PROBSE1308Q20STD**
- PROBSE1308Q20PR**
- PROBSE1308Q23STD**
- PROBSE1308Q23PR**
- PROBSE1308Q25HDC**

Relined Brake Shoe Kit\*

- PROBKE1308Q20STD**
- PROBKE1308Q20PR**
- PROBKE1308Q23STD**
- PROBKE1308Q23PR**
- PROBKE1308Q25HDC**

Pro-Par

**FMSI# 1443TT - 15 in. x 4 in.**

Eaton ES Front

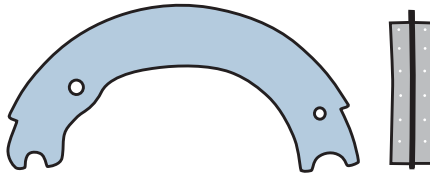

New Brake Shoe

- PROBSN1443E20STD**
- PROBSN1443E20PR**
- PROBSN1443E23STD**
- PROBSN1443E23PR**

New Brake Shoe Kit\*

- PROBKN1443E20STD**
- PROBKN1443E20PR**
- PROBKN1443E23STD**
- PROBKN1443E23PR**

**Hardware Kit**

Steering Axle  
**PROWB005**

Relined Brake Shoe

- PROBSE1443E20STD**
- PROBSE1443E20PR**
- PROBSE1443E23STD**
- PROBSE1443E23PR**
- PROBSE1443E25HDC**

Relined Brake Shoe Kit\*

- PROBKE1443E20STD**
- PROBKE1443E20PR**
- PROBKE1443E23STD**
- PROBKE1443E23PR**
- PROBKE1443E25HDC**

Pro-Par

Stocking Part Number  
Quote Part Number

\*Each Brake Shoe Kit comes boxed with  
(2) brake shoes and (1) hardware kit.

**AXL**

**Brakes**



## Brake Shoes

AXL

Brakes

### 15 in. Web 2

**FMSI# 4702Q - 15 in. x 4 in.**

Meritor Q Plus Front

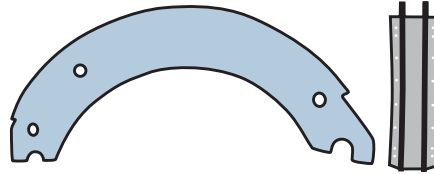

New Brake Shoe

**PROBSN4702Q20STD**  
**PROBSN4702Q20PR**  
**PROBSN4702Q23STD**  
**PROBSN4702Q23PR**

New Brake Shoe Kit\*

**PROBKN4702Q20STD**  
**PROBKN4702Q20PR**  
**PROBKN4702Q23STD**  
**PROBKN4702Q23PR**

### Hardware Kit

Steering Axle  
**PROWB006**

Relined Brake Shoe

**PROBSE4702Q20STD**  
**PROBSE4702Q20PR**  
**PROBSE4702Q23STD**  
**PROBSE4702Q23PR**  
**PROBSE4702Q25HDC**

Relined Brake Shoe Kit\*

**PROBKE4702Q20STD**  
**PROBKE4702Q20PR**  
**PROBKE4702Q23STD**  
**PROBKE4702Q23PR**  
**PROBKE4702Q25HDC**

Pro-Par

**FMSI# 4710Q - 15 in. x 8-5/8 in.**

Meritor Q Plus Front

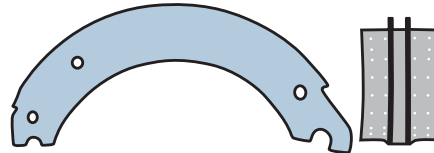

New Brake Shoe

**PROBSN4710Q20STD**  
**PROBSN4710Q20PR**  
**PROBSN4710Q23STD**  
**PROBSN4710Q23PR**

New Brake Shoe Kit\*

**PROBKN4710Q20STD**  
**PROBKN4710Q20PR**  
**PROBKN4710Q23STD**  
**PROBKN4710Q23PR**

### Hardware Kit

Trailer Axle  
**PROWB027**

Relined Brake Shoe

**PROBSE4710Q20STD**  
**PROBSE4710Q20PR**  
**PROBSE4710Q23STD**  
**PROBSE4710Q23PR**  
**PROBSE4710Q25HDC**

Relined Brake Shoe Kit\*

**PROBKE4710Q20STD**  
**PROBKE4710Q20PR**  
**PROBKE4710Q23STD**  
**PROBKE4710Q23PR**  
**PROBKE4710Q25HDC**

Pro-Par

Stocking Part Number  
 Quote Part Number

\*Each Brake Shoe Kit comes boxed with  
 (2) brake shoes and (1) hardware kit.

Brakes

140

800.621.7949

= Key Items

www.AuroraParts.com

## Brake Shoes

16-1/2 in. Web 2

**FMSI# 4311E - 16-1/2 in. x 7 in.**

Eaton Low Mount

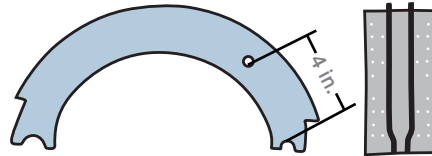

New Brake Shoe

**PROBSN4311E20STD**  
**PROBSN4311E20PR**  
**PROBSN4311E23STD**  
**PROBSN4311E23PR**

New Brake Shoe Kit\*

**PROBKN4311E20STD**  
**PROBKN4311E20PR**  
**PROBKN4311E23STD**  
**PROBKN4311E23PR**

### Hardware Kit

**PROWB002**

Relined Brake Shoe

**PROBSE4311E20STD**  
**PROBSE4311E20PR**  
**PROBSE4311E23STD**  
**PROBSE4311E23PR**  
**PROBSE4311E25HDC**

Relined Brake Shoe Kit\*

**PROBKE4311E20STD**  
**PROBKE4311E20PR**  
**PROBKE4311E23STD**  
**PROBKE4311E23PR**  
**PROBKE4311E25HDC**

Pro-Par

AXL

Brakes



## More Information

### Pro-Par Shoes & Kits

#### Bold Part Numbers - Stocking

All numbers listed in bold black are priced and available for ordering. These are the most common brakes and brake kits used by Aurora Dealers.

#### Gray Part Numbers - Quote Request

All numbers listed in gray are available upon request. Contact your Regional Sales Manager to get pricing and lead times.

#### Pro-Par Shoe Lining Colors



20K Standard  
Green



20K Premium  
Blue



23K Standard  
Orange



23K Premium  
Gold



25K HDC Heavy Duty Combo  
Dark Red

## Brake Shoes

AXL

Brakes

16-1/2 in. Web 2

**FMSI# 4515Q - 16-1/2 in. x 7 in.**

Meritor Q

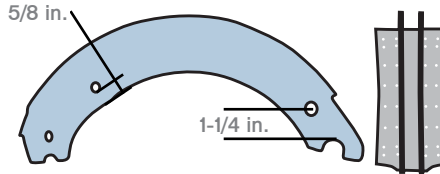

New Brake Shoe

**PROBSN4515Q20STD**  
**PROBSN4515Q20PR**  
**PROBSN4515Q23STD**  
**PROBSN4515Q23PR**

New Brake Shoe Kit\*

**PROBKN4515Q20STD**  
**PROBKN4515Q20PR**  
**PROBKN4515Q23STD**  
**PROBKN4515Q23PR**

### Hardware Kit

Trailer Axle

**PROWB047**

**PROWB001LD**

Trailer Axle

**PROWB001A**

Relined Brake Shoe

**PROBSE4515Q20STD**  
**PROBSE4515Q20PR**  
**PROBSE4515Q23STD**  
**PROBSE4515Q23PR**  
**PROBSE4515Q25HDC**

Relined Brake Shoe Kit\*

**PROBKE4515Q20STD**  
**PROBKE4515Q20PR**  
**PROBKE4515Q23STD**  
**PROBKE4515Q23PR**  
**PROBKE4515Q25HDC**

Pro-Par

**FMSI# 4515X - 16-1/2 in. x 7 in.**

Fruehauf XEM 3rd Generation

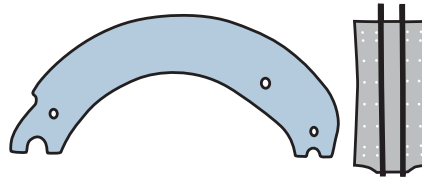

New Brake Shoe

**PROBSN4515X20STD**  
**PROBSN4515X20PR**  
**PROBSN4515X23STD**  
**PROBSN4515X23PR**

New Brake Shoe Kit\*

**PROBKN4515X20STD**  
**PROBKN4515X20PR**  
**PROBKN4515X23STD**  
**PROBKN4515X23PR**

### Hardware Kit

Trailer Axle

**PROWB003**

Relined Brake Shoe

**PROBSE4515X20STD**  
**PROBSE4515X20PR**  
**PROBSE4515X23STD**  
**PROBSE4515X23PR**  
**PROBSE4515X25HDC**

Relined Brake Shoe Kit\*

**PROBKE4515X20STD**  
**PROBKE4515X20PR**  
**PROBKE4515X23STD**  
**PROBKE4515X23PR**  
**PROBKE4515X25HDC**

Pro-Par

Stocking Part Number  
 Quote Part Number

\*Each Brake Shoe Kit comes boxed with  
 (2) brake shoes and (1) hardware kit.

Brakes



## Brake Shoes

16-1/2 in. Web 2

**FMSI# 4551B - 16-1/2 in. x 8-5/8 in.**

Meritor Q

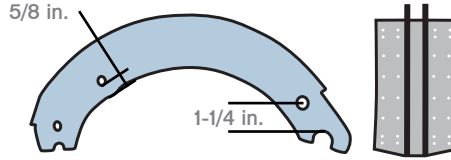

New Brake Shoe

**PROBSN4551Q20STD**  
**PROBSN4551Q20PR**  
**PROBSN4551Q23STD**  
**PROBSN4551Q23PR**

New Brake Shoe Kit\*

**PROBKN4551Q20STD**  
**PROBKN4551Q20PR**  
**PROBKN4551Q23STD**  
**PROBKN4551Q23PR**

### Hardware Kit

Trailer Axle  
**PROWB047**

**PROWB001LD**

Trailer Axle  
**PROWB001A**

Relined Brake Shoe

**PROBSE4551Q20STD**  
**PROBSE4551Q20PR**  
**PROBSE4551Q23STD**  
**PROBSE4551Q23PR**  
**PROBSE4551Q25HDC**

Relined Brake Shoe Kit\*

**PROBKE4551Q20STD**  
**PROBKE4551Q20PR**  
**PROBKE4551Q23STD**  
**PROBKE4551Q23PR**  
**PROBKE4551Q25HDC**

Pro-Par

**FMSI# 4707Q - 16-1/2 in. x 7 in.**

Meritor Q Plus, Spicer XTRALIFE II & Hendrickson INTRAAX

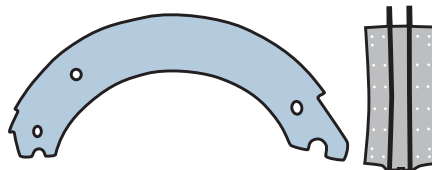

New Brake Shoe

**PROBSN4707Q20STD**  
**PROBSN4707Q20PR**  
**PROBSN4707Q23STD**  
**PROBSN4707Q23PR**

New Brake Shoe Kit\*

**PROBKN4707Q20STD**  
**PROBKN4707Q20PR**  
**PROBKN4707Q23STD**  
**PROBKN4707Q23PR**

### Hardware Kit

Trailer Axle  
**PROWB047**

Trailer Axle  
**PROWB01A**

Relined Brake Shoe

**PROBSE4707Q20STD**  
**PROBSE4707Q20PR**  
**PROBSE4707Q23STD**  
**PROBSE4707Q23PR**  
**PROBSE4707Q25HDC**

Relined Brake Shoe Kit\*

**PROBKE4707Q20STD**  
**PROBKE4707Q20PR**  
**PROBKE4707Q23STD**  
**PROBKE4707Q23PR**  
**PROBKE4707Q25HDC**  
**PROBKE4707Q23TFT**

Pro-Par

## Definition

Pro-Par Shoe Lining

TFT:

Transfer Film Technology - 23K, 165AL, high torque, high performance friction formulation utilizing aramid (Kevlar) fibers. Better lining/drum contact through greater conformability.

## Brake Shoes

AXL

Brakes

**16-1/2 in. Web 2**

**FMSI# 4709E2 - 16-1/2 in. x 7 in.**

Spicer ESII

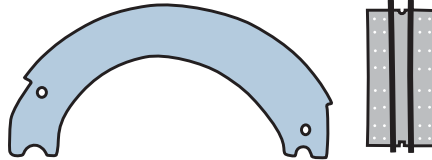

New Brake Shoe

**PROBSN4709E220STD**  
**PROBSN4709E220PR**  
**PROBSN4709E223STD**  
**PROBSN4709E223PR**

New Brake Shoe Kit\*

**PROBKN4709E220STD**  
**PROBKN4709E220PR**  
**PROBKN4709E223STD**  
**PROBKN4709E223PR**

### Hardware Kit

Drive Axle  
**PROWB046**

Relined Brake Shoe

**PROBSE4709E220STD**  
**PROBSE4709E220PR**  
**PROBSE4709E223STD**  
**PROBSE4709E223PR**  
**PROBSE4709E225HDC**

Relined Brake Shoe Kit\*

**PROBKE4709E220STD**  
**PROBKE4709E220PR**  
**PROBKE4709E223STD**  
**PROBKE4709E223PR**  
**PROBKE4709E225HDC**

Pro-Par

**FMSI# 4711Q - 16-1/2 in. x 8-5/8 in.**

Meritor Q Plus, Spicer XTRALIFE II  
 & Hendrickson INTRAAX

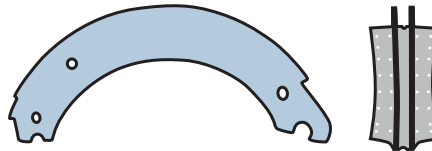

New Brake Shoe

**PROBSN4711Q20STD**  
**PROBSN4711Q20PR**  
**PROBSN4711Q23STD**  
**PROBSN4711Q23PR**

New Brake Shoe Kit\*

**PROBKN4711Q20STD**  
**PROBKN4711Q20PR**  
**PROBKN4711Q23STD**  
**PROBKN4711Q23PR**

### Hardware Kit

Trailer Axle  
**PROWB047**

Trailer Axle  
**PROWB001A**

Relined Brake Shoe

**PROBSE4711Q20STD**  
**PROBSE4711Q20PR**  
**PROBSE4711Q23STD**  
**PROBSE4711Q23PR**  
**PROBSE4711Q25HDC**

Relined Brake Shoe Kit\*

**PROBKE4711Q20STD**  
**PROBKE4711Q20PR**  
**PROBKE4711Q23STD**  
**PROBKE4711Q23PR**  
**PROBKE4711Q25HDC**

Pro-Par

Stocking Part Number  
 Quote Part Number

\*Each Brake Shoe Kit comes boxed with  
 (2) brake shoes and (1) hardware kit.

Brakes

144

800.621.7949

= Key Items

www.AuroraParts.com

## Brake Shoes

16-1/2 in. Web 2

### FMSI# 4715Q - 16-1/2 in. x 6 in.

Meritor Q Plus & Spicer XTRALIFE II

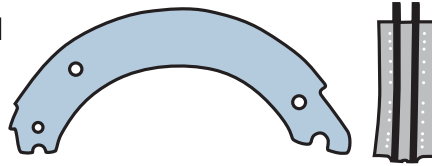

New Brake Shoe

**PROBSN4715Q20STD**  
**PROBSN4715Q20PR**  
**PROBSN4715Q23STD**  
**PROBSN4715Q23PR**

New Brake Shoe Kit\*

**PROBKN4715Q20STD**  
**PROBKN4715Q20PR**  
**PROBKN4715Q23STD**  
**PROBKN4715Q23PR**

### Hardware Kit

Trailer Axle

**PROWB047**

Steering Axle

**PROWB015**

Relined Brake Shoe

**PROBSE4715Q20STD**  
**PROBSE4715Q20PR**  
**PROBSE4715Q23STD**  
**PROBSE4715Q23PR**  
**PROBSE4715Q25HDC**

Relined Brake Shoe Kit\*

**PROBKE4715Q20STD**  
**PROBKE4715Q20PR**  
**PROBKE4715Q23STD**  
**PROBKE4715Q23PR**  
**PROBKE4715Q25HDC**

Pro-Par

### FMSI# 4718Q - 16-1/2 in. x 7 in.

Meritor Q Plus

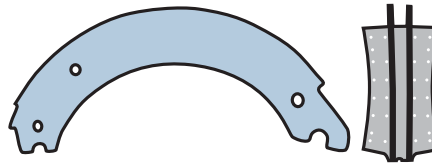

New Brake Shoe

**PROBSN4718Q20STD**  
**PROBSN4718Q20PR**  
**PROBSN4718Q23STD**  
**PROBSN4718Q23PR**

New Brake Shoe Kit\*

**PROBKN4718Q20STD**  
**PROBKN4718Q20PR**  
**PROBKN4718Q23STD**  
**PROBKN4718Q23PR**

### Hardware Kit

Trailer Axle

**PROWB047**

Trailer Axle

**PROWB001A**

Relined Brake Shoe

**PROBSE4718Q20STD**  
**PROBSE4718Q20PR**  
**PROBSE4718Q23STD**  
**PROBSE4718Q23PR**  
**PROBSE4718Q25HDC**

Relined Brake Shoe Kit\*

**PROBKE4718Q20STD**  
**PROBKE4718Q20PR**  
**PROBKE4718Q23STD**  
**PROBKE4718Q23PR**  
**PROBKE4718Q25HDC**

Pro-Par

Stocking Part Number  
 Quote Part Number

\*Each Brake Shoe Kit comes boxed with (2) brake shoes and (1) hardware kit.

AXL

Brakes



## Brake Shoes

AXL

Brakes

### Additional Shoes

	FMSI#	Lining	Application
<b>PROBSE1477TMHS</b>	1477	Hi Temp	16-9/16 in. x 7-3/16 in., Intermodal
<b>PROBSE4591DX23PR</b>	4591	23K Premium	12-1/4 in. x 7-1/2 in.
<b>PROBSE4591SF23PR</b>	4591SF	23K Premium	12-1/4 in. x 7-1/2 in., Standard Forge
<b>PROBSE4707Q23HD</b>	4707Q+	23K Premium	Meritor Q Plus, Spicer XTRALIFE II & Hendrickson INTRAAX
<b>PROBSE4709E20PR</b>	4709	20K Premium	16-1/2 in. x 7 in., Spicer ES
<b>PROBSE4709E23PR</b>	4709	23K Premium	16-1/2 in. x 7 in., Spicer ES
<b>PROBSE4720Q23PR</b>	4720Q	23K Premium	16-1/2 in. x 5 in., Mertior Q Plus, Spicer XTRALIFE II
<b>PROBSE4726E223PR</b>	4726E2	23K Premium	16-1/2 in. x 8-1/2 in., Spicer ES 11



(PROBSE1477TMHS)



(PROBSE4591DX23PR)



(PROBSE4707Q23HD)

### Pro-Par

### Additional Kits

	FMSI#	Lining	Application
<b>PROBKE4726E220PR<sup>^</sup></b>	4726E2	20K Premium	16-1/2 in. x 8-5/8 in., Spicer ES2
<b>PROBKE4670Q23PR<sup>^</sup></b>	4670Q	23K Premium	12-1/4 in. x 7-1/2 in., Meritor Q
<b>PROBKE4708Q20PR<sup>^</sup></b>	4708Q	20K Premium	16-1/2 in. x 7 in., Spicer ES2
<b>PROBKE4709E20STD<sup>^</sup></b>	4709	20K Standard	16-1/2 in. x 7 in., Spicer ES
<b>PROBKE4719E220PR<sup>^</sup></b>	4719E2	20K Premium	16-1/2 in. x 5 in., Spicer ES 11
<b>PROBKE4720Q20PR<sup>^</sup></b>	4720Q	20K Premium	16-1/2 in. x 5 in., Mertior Q Plus, Spicer XTRALIFE II
<b>PROBKE4720Q23PR<sup>^</sup></b>	4720Q	23K Premium	16-1/2 in. x 5 in., Mertior Q Plus, Spicer XTRALIFE II



(PROBKE4726E220PR)



(PROBKE4670Q23PR)



(PROBKE4708Q20PR)



(PROBKE4709E20STD)



(PROBKE4719E220PR)



(PROBKE4720Q20PR)

### Pro-Par

<sup>^</sup>Each Brake Shoe Kit comes boxed with (2) brake shoes and (1) hardware kit.

## Camshafts

1-1/2 in. - 10 Spline

### Multi-Application 16-1/2 in. Brakes

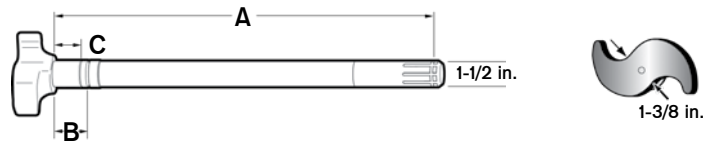

	Head End	Cross Reference	A	B	C	Cam Repair Kit(s):
<b>PROWC506L</b>	LH	Meritor 2210-F-5414; Spicer M-16WK-110-5; Euclid E1425	20-3/8 in.	2-7/32 in.	1-5/8 in.	PROWCR1402, PROWCR1410, PROWCR1417, PROWCR1422
<b>PROWC507R</b>	RH	Meritor 2210-E-5413; Spicer M-16WK-111-5; Euclid E1424				
<b>PROWC522L</b>	LH	Eaton B-1691-25; Spicer M-16WK-110-9; Euclid E1095	23-7/16 in.	2-7/32 in.	1-5/8 in.	
<b>PROWC523R</b>	RH	Eaton B-1691-26; Spicer M-16WK-111-9; Euclid E1094				

1-1/2 in. - 28 Spline

### Eaton Trailer Axles 16-1/2 in. "ES" Brakes

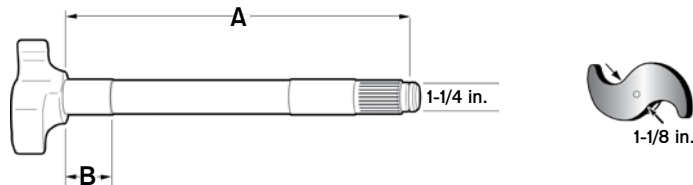

	Head End	Cross Reference	A	B	Cam Repair Kit(s):
<b>PROWC226L</b>	LH	Eaton 810025; Euclid E9059	23-11/16 in.	2-7/32 in.	PROWCR1420
<b>PROWC227R</b>	RH	Eaton 810026; Euclid E9060			

### Hendrickson "XLS" Trailer Axles 16-1/2 in. Brakes

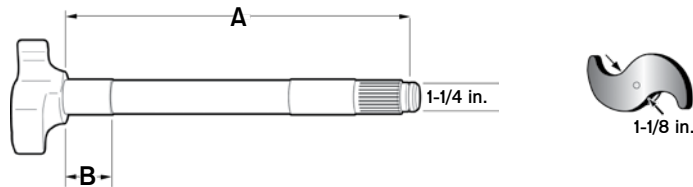

	Head End	Cross Reference	A	B	Cam Repair Kit(s):
<b>HENS-24636-1L</b>	LH	Pro-Par PROWC2023L	11-1/32 in.	2-5/16 in.	HENS-23974, HENS-28890, PROWCR1439, PROWCR1439HD, PROWCR1448-1
<b>HENS-24636-1R</b>	RH	Pro-Par PROWC2023R			
<b>PROWC2032L</b>	LH	Euclid E11866; Hendrickson S-24636-1L	11-1/32 in.	2-5/16 in.	
<b>PROWC2033R</b>	RH	Euclid E11867; Hendrickson S-24636-1R			

AXL

Camshafts



## Camshafts

### 1-1/2 in. - 28 Spline

#### Meritor Trailer Axles 12-1/4 in. "Q" Brakes

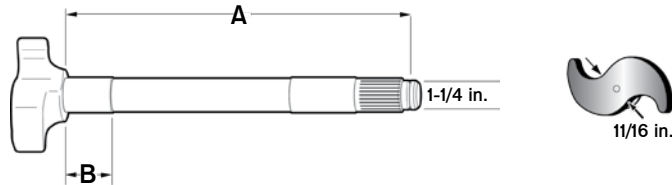

	Head End	Cross Reference	A	B	Cam Repair Kit(s):
<b>PROWC372L</b>	LH	Meritor 2210-E-6167; Euclid E9087	23-7/32 in.	1-23/32 in.	PROWCRI444
<b>PROWC373R</b>	RH	Meritor 2210-F-6168; Euclid E9088			

#### Meritor Trailer Axles 16-1/2 in. "Q+" Brakes

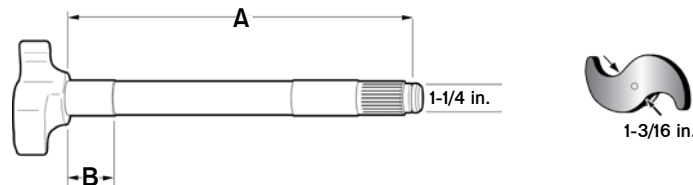

	Head End	Cross Reference	A	B	Cam Repair Kit(s):
<b>PROWCQ312L</b>	LH	Meritor 2210-W-7537; Euclid E9661	11-19/32 in.	1-13/16 in.	PROWCRI425, PROWCRI430, PROWCRI433, PROWCRI434
<b>PROWCQ313R</b>	RH	Meritor 2210-V-7536; Euclid E9662			
<b>PROWCQ350L</b>	LH	Meritor 2210-C-6867; Euclid E5506	17-5/16 in.	1-63/64 in.	PROWCRI442, PROWCRI442HD, PROWCRI443, MTRKIT-8091, MTRKIT-8078A, MTRKIT8289
<b>PROWCQ351R</b>	RH	Meritor 2210-B-6866; Euclid E5507			
<b>MTR2210C6867</b>	LH	Pro-Par PROWCQ350L	17-3/8 in.	1-63/64 in.	PROWCRI442, PROWCRI442HD, PROWCRI443, MTRKIT-8091, MTRKIT-8078A, MTRKIT8289
<b>MTR2210B6866</b>	RH	Pro-Par PROWCQ351R			
<b>PROWCQ364L</b>	LH	Meritor 2210-R-8156; Euclid E2441B	17-5/16 in.	1-45/64 in.	PROWCRI442, PROWCRI442HD, PROWCRI443, MTRKIT-8091, MTRKIT-8078A, MTRKIT8289
<b>PROWCQ365R</b>	RH	Meritor 2210-Q-8155; Euclid E2442B			
<b>PROWCQ352L</b>	LH	Meritor 2210-G-6871; Euclid E5508	20-13/32 in.	1-63/64 in.	PROWCRI442, PROWCRI442HD, PROWCRI443, MTRKIT-8091, MTRKIT-8078A, MTRKIT8289
<b>PROWCQ353R</b>	RH	Meritor 2210-F-6870; Euclid E5509			
<b>PROWCQ366L</b>	LH	Meritor 2210-T-8158; Euclid E2443B	20-13/32 in.	1-45/64 in.	PROWCRI442, PROWCRI442HD, PROWCRI443, MTRKIT-8091, MTRKIT-8078A, MTRKIT8289
<b>PROWCQ367R</b>	RH	Meritor 2210-S-8157; Euclid E2444B			
<b>PROWCQ354L</b>	LH	Meritor 2210-E-6869; Euclid E5510	24-1/16 in.	1-63/64 in.	PROWCRI442, PROWCRI442HD, PROWCRI443, MTRKIT-8091, MTRKIT-8078A, MTRKIT8289
<b>PROWCQ355R</b>	RH	Meritor 2210-D-6868; Euclid E5511			
<b>MTR2210E6869</b>	LH	Pro-Par PROWCQ354L	24-1/16 in.	1-63/64 in.	PROWCRI442, PROWCRI442HD, PROWCRI443, MTRKIT-8091, MTRKIT-8078A, MTRKIT8289
<b>MTR2210D6868</b>	RH	Pro-Par PROWCQ355R			
<b>PROWCQ368L</b>	LH	Meritor 2210-V-8160; ; Euclid E2445B	24-1/16 in.	1-45/64 in.	PROWCRI442, PROWCRI442HD, PROWCRI443, MTRKIT-8091, MTRKIT-8078A, MTRKIT8289
<b>PROWCQ369R</b>	RH	Meritor 2210-U-8159; Euclid E2446B			

AXL

Camshafts





## Camshafts

1-1/2 in. - 28 Spline

### Meritor Trailer Axles 16-1/2 in. Brakes

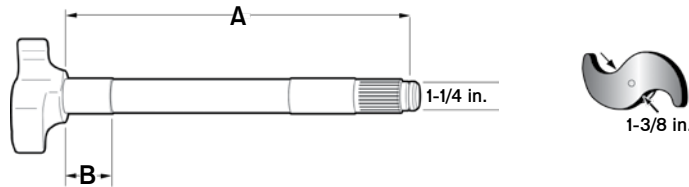

Head End	Cross Reference	A	B	Cam Repair Kit(s):
<b>PROWC504L</b>	LH Meritor 2210-M-4329; Euclid E2441A			
<b>PROWC505R</b>	RH Meritor 2210-L-4328; Euclid E2442A	17-5/16 in.	1-23/32 in.	PROWCR1419, PROWCR1432, PROWCR1442
<b>PROWC526L</b>	LH Meritor 2210-R-4334; Euclid E2443A			
<b>PROWC527R</b>	RH Meritor 2210-Q-4333; Euclid E2444A	20-13/32 in.	1-23/32 in.	

### Spicer Axles 12-1/4 in. Brakes (After Feb. 1996)

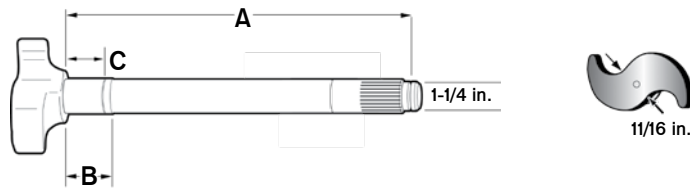

Head End	Cross Reference	A	B	C	Cam Repair Kit(s):
<b>PROWC886L</b>	LH Spicer M12WKL25-233; Euclid E10905L				PROWCR1444
<b>PROWC887R</b>	RH Spicer M12WKR25-233; Euclid E10906R	23-1/8 in.	2-21/32 in.	2-7/32 in.	

### Spicer Trailer Axles 16-1/2 in. & 18 in. Brakes

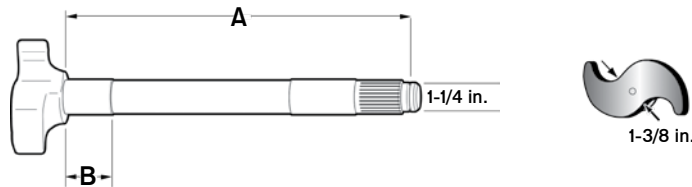

Head End	Cross Reference	A	B	Cam Repair Kit(s):
<b>PROWC422L</b>	LH Spicer M-16WK104-24; Euclid E3856			PROWCR1410, PROWCR1445
<b>PROWC423R</b>	RH Spicer M-16WK105-24; Euclid E3857	23-1/2 in.	2-7/32 in.	

AXL

Camshafts



## Camshafts

AXL

Camshafts

### 1-1/2 in. - 28 Spline

#### Spicer Trailer Axles 16-1/2 in. "XL" Brakes

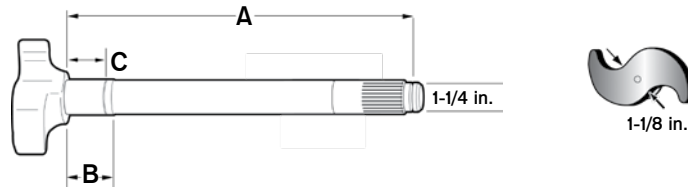

	Head End	Cross Reference	A	B	C	Cam Repair Kit(s):
<b>PROWC168L</b>	LH	Spicer M16WKL25-175; Euclid E9731				
<b>PROWC169R</b>	RH	Spicer 216WKR25-175; Euclid E9732	17-3/8 in.	2-7/32 in.		PROWCR1444
<b>PROWC154L</b>	LH	Spicer M16WKL20-205; Euclid E5524				
<b>PROWC155R</b>	RH	Spicer M16WKR20-205; Euclid E5525	20-3/8 in.	2-7/32 in.	1-5/8 in.	PROWCR1410, PROWCR1445
<b>PROWC170L</b>	LH	Spicer M16WKL25-205; Euclid E9733				
<b>PROWC171R</b>	RH	Spicer M16WKR25-205; Euclid E9734	20-3/8 in.	2-7/32 in.		PROWCR1444
<b>PROWC158L</b>	LH	Spicer M16WKL20-236; Euclid E5526				
<b>PROWC159R</b>	RH	Spicer M16WKR20-236; Euclid E5527	23-1/2 in.	2-7/32 in.	1-5/8 in.	PROWCR1410, PROWCR1445
<b>PROWC172L</b>	LH	Spicer M16WKL25-236; Euclid E9735	23-1/2 in.	2-7/32 in.		PROWCR1444
<b>PROWC173R</b>	RH	Spicer M16WKR25-236; Euclid E9736				
<b>PROWC162L</b>	LH	Spicer M16WKL20-242; Euclid E9100				
<b>PROWC163R</b>	RH	Spicer M16WKR20-242; Euclid E9101	24 in.	2-7/32 in.	1-5/8 in.	PROWCR1410, PROWCR1445
<b>PROWC176L</b>	LH	Spicer M16WKL25-242; Euclid E10909L				
<b>PROWC177R</b>	RH	Spicer M16WKR25-242; Euclid E10910R	24-1/8 in.	2-7/32 in.		
<b>PROWC706L</b>	LH	Spicer M16WKL25-264				PROWCR1444
<b>PROWC707R</b>	RH	Spicer M16WKR25-264	26-1/4 in.	2-7/32 in.		

### 1-5/8 in. - 37 Spline

#### Fruehauf Axles 16-1/2 in. "Pro-Par" Brakes

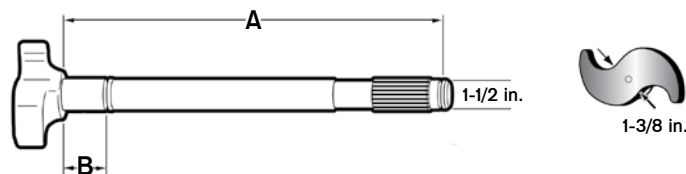

	Head End	Cross Reference	A	B	Cam Repair Kit(s):
<b>PROWC528L</b>	LH	Fruehauf AXA-0420-1; Euclid E1563			
<b>PROWC529R</b>	RH	Fruehauf AXA-0420-2; Euclid E1564	16-1/8 in.	2-5/32 in.	PROWCR1407, PROWCR1408, FRUACF4024-900
<b>PROWC512L</b>	LH	Fruehauf AXA-0420-3; Euclid E2099			
<b>PROWC513R</b>	RH	Fruehauf AXA-0420-4; Euclid E2100	21-1/8 in.	2-5/32 in.	

## Cam Repair Kits

### DAN43-7118

Qty	Description
1	LH Bracket Assy
1	RH Bracket Assy
2	Lock Ring
2	Lock Ring
2	Lock Ring
2	Spider Bushing
2	Washer
2	Washer
2	Washer
2	Washer
8	Self Tapping Screw
4	Spider Seal



Brake Diameter: 16-1/2 in.  
1-5/8 in. Spider

Bendix

### DAN127808

Qty	Description
4	Bushing
4	Seal
2	Lock Ring



Brake Diameter: 16-1/2 in.  
For Dana RF/RS Suspensions

Bendix

### HENS-23974

Qty	Description
4	Seal
2	Lock
2	Bronze Bushing
6	Washer
2	Lock
4	Washer
2	Bracket
2	Washer



Brake Diameter: 16-1/2 in.  
Hendrickson "INTRAAX" "HXS" Series

Hendrickson

## Tech Tip

### S-Cam Bushings

S-cam bushings must be checked at every reline. If either the bushing or s-cam itself is worn out, failure to repair/replace the s-cam will cause problems with the system.

AXL

Camshafts

Bendix

HENDRICKSON

## Cam Repair Kits

AXL

Camshafts

### Tube Kit

#### HENS-28890

Qty	Description
1	Tube
1	Washer
2	Washer
3	Washer
2	Lock Ring
4	Bolt
4	Nut
2	Bracket



Brake Diameter: 16-1/2 in.  
Tube Size: 8-3/8 in.

### Hendrickson

#### HENS-31964

Qty	Description
2	Bushing
4	Lock Ring
2	Snap Ring
8	Bolt
8	Nut
4	Seal
20	Washer



### Hendrickson

#### HOL51830001

Qty	Description
8	Bolt
8	Nut
4	Seal
4	Snap Ring
10	Washer
2	Grease Fitting
2	Bracket Assy



Brake Diameter: 16-1/2 in.

### SAF-Holland

#### HOL51830024

Qty	Description
8	Bolt
8	Nut
4	Seal
10	Washer
2	Bushing
4	Snap Ring
2	Grease Fitting
2	Bracket Assy



Brake Diameter: 16-1/2 in.

### SAF-Holland

HENDRICKSON

SAF-Holland

## Cam Repair Kits

### MTRKIT8048

Qty	Description
2	Lock
4	Washer
2	Washer
2	Washer
2	Lock
2	Assembly
2	Lock
2	Bracket



Brake Diameter: 12-1/4 in. & 16-1/2 in. P & Q  
Fit: E3520A , per Axle

Meritor

	Services
MTRKIT8078	1 Wheel
MTRKIT8078A	2 Wheels

Qty	Description
2	Lock Ring
4	Washer
8	Bolt
2	Bushing
2	Washer
2	Washer
2	Snap Ring
4	Seal
2	Retainer Assembly



Brake Diameter: 16-1/2 in. Q

Meritor

### MTRKIT8289

Qty	Description
1	Washer
1	Washer
1	Snap Ring
1	Bushing Retainer Assembly
4	Bolt
2	Seal



Brake Diameter: 16-1/2 in. Q  
Services One Brake

Meritor

### MTRKIT8091

Qty	Description
2	Lock Ring
4	Washer
8	Bolt
2	Bushing
2	Washer
2	Washer
2	Snap Ring
4	Seal
2	Retainer Assembly



Brake Diameter: 16-1/2 in.  
Fit: Meritor Q & Q+ with Bolt-On Bushing

Meritor

AXL

Camshafts



## Cam Repair Kits

AXL

Camshafts

### PROWCR1403

Qty	Part Number	Description
2	PROWC8847	Lock
4	PROWC8831	Washer
2	PROWC8827	Washer
2	PROWC8848	Washer
4	PROWC8878	O-Ring
2	PROWC8843	Lock
2	PROWC8879	Bushing
2	PROWCBR1416	Assembly
2	PROWC8849	Lock



Brake Diameter: 16-1/2 in. & 12-1/4 in.  
Fit: Meritor 4000-6000 Q Trailer Axle

### Pro-Par

### PROWCR1407

Qty	Part Number	Description
2	PROWC8841	Lock Ring
2	PROWC8824	Washer
6	PROWC8828	Washer
4	PROWC8805	Bushing
2	PROWC8843	Lock Ring
2	PROWC8858	Bushing



Brake Diameter: 12-1/4 in. & 16-1/2 in.  
Fit: Fruehauf Pro-Par XEM & FQ Series

### Pro-Par

## Pro-Par Camshaft Guide

### Camshaft / Cam Repair Kit / Slack Adjuster

Camshaft	Cam Repair Kit	Slack Adjuster Options	
PROWC052L	PROWCR1406	PROSA56142	
PROWC053R			
PROWC084L			
PROWC085R	PROWCR1410, PROWCR1445	- Auto 5 in., 6 in. Drive PROSA56143	
PROWC104L	PROWCR1412, PROWCR1418, PROWCR1445, PROWCR1426	- Auto 5-1/2 in., 6-1/2 in. Drive PROSA56215	
PROWC105R		- Auto 5-1/2 in. Straight PROSA56216	
PROWC130L	PROWCR1410, PROWCR1445	- Auto 6 in. Straight	
PROWC131R			
PROWC152L			
PROWC153R			
PROWC154L			
PROWC155R			
PROWC158L			
PROWC159R			
PROWC162L			
PROWC163R			
PROWC168L		PROWCR1444	- Auto 5-1/2 in. Straight PROSA56212
PROWC169R			- Auto 6 in. Straight

Camshaft	Cam Repair Kit	Slack Adjuster Options
PROWC170L	PROWCR1444	PROSA55073 - Auto 5-1/2 in. Straight PROSA56074 - Auto 6 in. Straight PROSA56140 - Auto 5 in., 6 in. Drive PROSA56144
PROWC171R		
PROWC172L		
PROWC173R		
PROWC176L		
PROWC177R		
PROWC2032L	PROWCR1439, PROWCR1439HD, PROWCR1448-1	- Auto 6 in. Drive Mack PROSA56175 - Auto 6 in. Straight PROSA56211
PROWC2033R	PROWCR1420	- Auto 5-1/2 in. Straight PROSA56212 - Auto 6 in. Straight
PROWC226L		
PROWC227R		
PROWC292L		PROSA56215 - Auto 5-1/2 in. Straight PROSA56216 - Auto 6 in. Straight
PROWC293R		





## Pro-Par Camshaft Guide

### Camshaft / Cam Repair Kit / Slack Adjuster

Camshaft	Cam Repair Kit	Slack Adjuster Options
PROWC372L	PROWCR1444	PROSA55073 / PROSA56211
PROWC373R		- Auto 5-1/2 in. Straight
PROWC418L	PROWCR1410, PROWCR1445	PROSA56074
PROWC419R		- Auto 6 in. Straight
PROWC422L		PROSA56175
PROWC423R		- Auto 6 in. Straight
		PROSA56212
	- Auto 6 in. Straight	
PROWC502L	PROWCR1406, PROWCR1431Z	PROSA6215
PROWC503R		- Auto 5-1/2 in. Straight
		PROSA6216
		- Auto 6 in. Straight
PROWC504L	PROWCR1419, PROWCR1432, PROWCR1442	PROSA55073 / PROSA56211
PROWC505R		- Auto 5-1/2 in. Straight
		PROSA56074 / PROSA56175
		- Auto 6 in. Straight
PROWC506L	PROWCR1402, PROWCR1410, PROWCR1417, PROWCR1422	PROSA56215
PROWC507R		- Auto 5-1/2 in. Straight
		PROSA56216
		- Auto 6 in. Straight
PROWC512L	PROWCR1407, PROWCR1408	PROSA56214
PROWC513R		- Auto 6 in. Straight
PROWC522L	PROWCR1402, PROWCR1410, PROWCR1417, PROWCR1422	PROSA6215
PROWC523R		- Auto 5-1/2 in. Straight
		PROSA56216
		- Auto 6 in. Straight
PROWC526L	PROWCR1419, PROWCR1432, PROWCR1442	PROSA55073 / PROSA56211
PROWC527R		- Auto 5-1/2 in. Straight
		PROSA56074 / PROSA56175
		- Auto 6 in. Straight
PROWC528L	PROWCR1407, PROWCR1408	PROSA56214
PROWC529R		- Auto 6 in. Straight
PROWC546L	PROWCR1402, PROWCR1410, PROWCR1417, PROWCR1422	PROSA56215
PROWC547R		- Auto 5-1/2 in. Straight
PROWC570L		PROSA56216
PROWC571R		- Auto 6 in. Straight
PROWC706L	PROWCR1444	PROSA55073 / PROSA56211
PROWC707R		- Auto 5-1/2 in. Straight
		PROSA56074 / PROSA56175
		- Auto 6 in. Straight
PROWC758L	PROWCR1419, PROWCR1432, PROWCR1442	PROSA56212
PROWC759R		- Auto 6 in. Straight

Camshaft	Cam Repair Kit	Slack Adjuster Options	
PROWC764L	PROWCR1402, PROWCR1410, PROWCR1417, PROWCR1422	PROSA56215 - Auto 5-1/2 in. Straight PROSA56216 - Auto 6 in. Straight	
PROWC765R			
PROWC766L	PROWCR1444		
PROWC767R			
PROWC812L	PROWCR1407, PROWCR1408		PROSA56214
PROWC813R		- Auto 6 in. Straight	
PROWC8363R	PROWCR1410, PROWCR1445	PROSA55073 - Auto 5-1/2 in. Straight PROSA56074 - Auto 6 in. Straight PROSA56140 - Auto 5 in., 6 in. Drive PROSA56141 - Auto 5-1/2 in., 6-1/2 in. Drive PROSA56144 - Auto 6 in. Drive Mack PROSA56175 - Auto 6 in. Straight PROSA56211 - Auto 5-1/2 in. Straight PROSA6212 - Auto 6 in. Straight	
PROWC8364L			
PROWC854L	PROWCR1419, PROWCR1432, PROWCR1442		
PROWC855R			
PROWC858L			
PROWC859R	PROWCR1444		
PROWC886L			
PROWC887R			
PROWC970L	PROWCR1436, PROWCR1439, PROWCR1439HD, PROWCR1448-1		PROSA56144
PROWC971R			- Auto 6 in. Drive Mack
		PROSA56175	
		- Auto 6 in. Straight	
PROWCQ2244L	PROWCR1425, PROWCR1430, PROWCR1433, PROWCR1434	PROSA56211	
PROWCQ2245R		- Auto 5-1/2 in. Straight	
PROWCQ310L		PROSA6212	
PROWCQ311R		- Auto 6 in. Straight	
PROWCQ312L			
PROWCQ313R			
PROWCQ350L		PROWCR1442, PROWCR1442HD, PROWCR1443	PROSA55073
PROWCQ351R	- Auto 5-1/2 in. Straight		
PROWCQ352L	PROSA56074		
PROWCQ353R	- Auto 6 in. Straight		
PROWCQ354L	PROSA56140		
PROWCQ355R	- Auto 5 in., 6 in. Drive		
PROWCQ364L	PROSA56141		
PROWCQ365R	- Auto 5-1/2 in., 6-1/2 in. Drive		
PROWCQ366L	PROSA56144		
PROWCQ367R	- Auto 6 in. Drive Mack		
PROWCQ368L	PROSA56175		
PROWCQ369R	- Auto 6 in. Straight		
			PROSA56211
		- Auto 5-1/2 in. Straight	
		PROSA6212	
		- Auto 6 in. Straight	
PROWCQ506L	PROWCR1402, PROWCR1410, PROWCR1417, PROWCR1422	PROSA56215	
PROWCQ507R		- Auto 5-1/2 in. Straight	
		PROSA56216	
		- Auto 6 in. Straight	

AXL

Camshafts



## Cam Repair Kits

AXL

Camshafts

### PROWC1407A

Qty	Part Number	Description
1	PROWC8841	Lock Ring
1	PROWC8824	Washer
3	PROWC8828	Washer
2	PROWC8805	Bushing
1	PROWC8843	Lock Ring
1	PROWC8858	Bushing



Brake Diameter: 16-1/2 in.  
Fit: Fruehauf Pro-Par XEM & FQ Series

Pro-Par

### PROWC1410

Qty	Part Number	Description
2	PROWC8847	Lock
4	PROWC8827	Washer
2	PROWC8851	Bushing
4	PROWC8841	Lock
2	PROWC8853	Bushing
2	PROWC8824	Washer
2	PROWC8826	Washer
4	PROWC8822A	Seal
2	PROWC8829	Washer
2	PROWC8849	Lock



Brake Diameter: 16-1/2 in.  
Fit: Dana FC & Xtra-Life Series

Pro-Par

### PROWC1412

Qty	Part Number	Description
2	PROWC8851	Bushing
4	PROWC8841	Lock Ring
2	PROWC8823	Washer
2	PROWC8853	Bushing
2	PROWC8824	Washer
4	PROWC8822A	Seal
2	PROWC8830	Washer
2	PROWC8829	Washer



Brake Diameter: 12-1/4 in.  
Fit: Spicer & Standard Forge Late Model Axles

Pro-Par

### PROWC1412Z

Qty	Part Number	Description
2	PROWC8854	Bronze Bushing
4	PROWC8841	Lock Ring
2	PROWC8853	Bushing
2	PROWC8824	Washer
4	PROWC8822A	Seal
2	PROWC8830	Washer
2	PROWC8829	Washer



Brake Diameter: 12-1/4 in.  
Fit: Spicer U Brake

Pro-Par



## Cam Repair Kits

### PROWCR1417

Qty	Part Number	Description
4	PROWC8841	Lock Ring
8	PROWC8848	Washer
2	PROWCBR1415	Assembly
2	PROWC8696	Bracket
2	PROWC8872	Lock Ring



Brake Diameter: 16-1/2 in.  
Fit: Meritor P Trailer Brake with 1-1/2 in. Diameter

Pro-Par

### PROWCR1419

Qty	Part Number	Description
2	PROWC8847	Lock
4	PROWC8831	Washer
2	PROWC8827	Washer
2	PROWC8848	Washer
2	PROWC8843	Lock
2	PROWCBR1416	Assembly
2	PROWC8849	Lock
2	PROWC8696	Bracket



Brake Diameter: 12-1/4 in. & 16-1/2 in.  
Fit: Meritor 4000-6000 Series with Support Bracket

Pro-Par

### Heavy Duty

### PROWCR1419HD

Qty	Part Number	Description
2	PROWC8847	Lock
4	PROWC8831	Washer
2	PROWC8827	Washer
2	PROWC8848	Washer
2	PROWC8843	Lock
2	PROWCBR1416	Assembly
2	PROWC8849	Lock
2	PROWC8696HD	Heavy Duty Bracket



Brake Diameter: 12-1/4 in. & 16-1/2 in.  
Fit: Meritor 4000-6000 Series with Support Bracket

Pro-Par

### PROWCR1420

Qty	Part Number	Description
2	PROWC8847	Lock Ring
2	PROWC8841	Lock Ring
4	PROWC8824	Washer
4	PROWC8828	Washer
2	PROWC8843	Lock Ring
4	PROWC8800	Seal
2	PROWC8881	Bushing
2	PROWC8882	Bushing



Brake Diameter: 16-1/2 in.  
Fit: Eaton 501, EB & ES

Pro-Par

AXL

Camshafts



## Cam Repair Kits

AXL

Camshafts

### PROWCR1423

Qty	Part Number	Description
2	PROWC8847	Lock
2	PROWC8854	Bronze Bushing
2	PROWC8827	Washer
4	PROWC8841	Lock
2	PROWC8823	Washer
2	PROWC8853	Bushing
2	PROWC8824	Washer
4	PROWC8822A	Seal



Brake Diameter: 16-1/2 in.  
Fit: Spicer Axle with Spherical Cam Bushing

Pro-Par

### PROWCR1425

Qty	Part Number	Description
2	PROWC8847	Lock Ring
4	PROWC8827	Washer
4	PROWC8818	Bushing
4	PROWC8820	Seal
2	PROWC8878	O-Ring
2	PROWC8849	Lock Ring
2	PROWC8873	Gasket
2	PROWC8821	Washer
2	PROWC8833	Washer



Brake Diameter: 16-1/2 in.  
Fit: For Meritor 15 & 16-1/2 in. Q & Q+

Pro-Par

### Heavy Duty

### PROWCR1435HD

Qty	Part Number	Description
4	PROWC8831	Washer
4	PROWC8827	Washer
2	PROWC8848	Washer
2	PROWC8843	Lock
4	PROWC8800	Seal
2	PROWC8849	Lock
2	PROWC8696HD	Heavy Duty Bracket
2	PROWC8885	Bronze Bushing
2	PROWC8837	Washer
2	PROWC8883	Washer
2	PROWC8847	Lock
2	PROWC8884	Lock
2	PROWC8886	Washer



Brake Diameter: 16-1/2 in.  
Fit: Meritor Q and Q+ with press in bushing

Pro-Par



## Cam Repair Kits

### PROWCR1436

Qty	Part Number	Description
2	PROWC8844	Lock Ring
2	PROWC8854	Bronze Bushing
2	PROWC8827	Lock Ring
2	PROWC8825	Washer
8	PROWC8848	Washer
4	PROWC8826	Washer
4	PROWC8822	Seal
2	PROWC8872	Lock Ring
2	PROWC8696	Bracket



Brake Diameter: 16-1/2 in.  
Fit: Hendrickson INTRAAX

Pro-Par

### PROWCR1437

Qty	Part Number	Description
2	PROWC8847	Lock
2	PROWC8855	Washer
2	PROWC8856	Spacer
2	PROWC8857	Bronze Bushing
4	PROWC8827	Washer
2	PROWC8853A	Bushing
2	PROWC8824	Washer
2	PROWC8843	Lock
4	PROWC8800	Seal



Brake Diameter: 16-1/2 in.  
Fit: Dana Xtra-Life with 1-5/8 in. Camshaft

Pro-Par

### PROWCR1439

Qty	Part Number	Description
4	PROWC8810	Seal
2	PROWC8847	Lock Ring
2	PROWC8808	Bronze Bushing
6	PROWC8827	Washer
2	PROWC8841	Lock Ring
8	PROWC8824	Washer
2	PROWC8696	Bracket
2	PROWC8809	Washer



Brake Diameter: 16-1/2 in.  
Fit: Hendrickson INTRAAX HXS

Pro-Par

### Tech Tip

#### Wear Points

Under the head and where the s-cam bushing rests are common wear points. The s-cam will need to be repaired/replaced if it has .0015 of an inch of wear.

AXL

Camshafts





## Cam Repair Kits

AXL

Camshafts

### Heavy Duty

#### PROWCR1439HD

Qty	Part Number	Description
4	PROWC8810	Seal
2	PROWC8847	Lock Ring
2	PROWC8808	Bronze Bushing
6	PROWC8827	Washer
2	PROWC8841	Lock Ring
8	PROWC8824	Washer
2	PROWC8696HD	Heavy Duty Bracket
2	PROWC8809	Washer



Brake Diameter: 16-1/2 in.  
Fit: Hendrickson INTRAAX HXS

### Pro-Par

#### PROWCR1442

Qty	Part Number	Description
2	PROWC8847	Lock
2	PROWC8827	Washer
2	PROWC8848	Washer
4	PROWC8800	Seal
2	PROWC8884	Lock
2	PROWC8849	Lock
2	PROWC8696	Bracket
2	PROWCBR1446	Bracket Kit
2	PROWC8838	Washer
2	PROWC8836	Washer



Brake Diameter: 16-1/2 in.  
Fit: Meritor Q & Q+ with Bolt-On Bushing

### Pro-Par

### Heavy Duty

	Services
<b>PROWCR1442HD</b>	2 Wheels
<b>PROWCR1442HDA</b>	1 Wheel

Qty	Part Number	Description
2	PROWC8847	Lock
2	PROWC8827	Washer
2	PROWC8848	Washer
4	PROWC8800	Seal
2	PROWC8884	Lock
2	PROWC8849	Lock
2	PROWC8696HD	Heavy Duty Bracket
2	PROWCBR1446	Bracket Kit
2	PROWC8838	Washer
2	PROWC8836	Washer

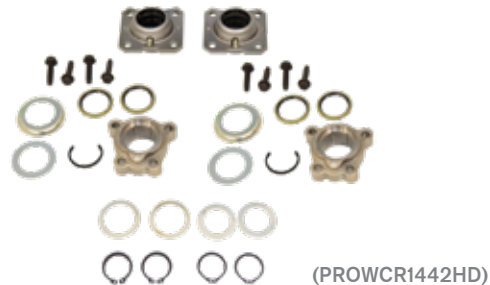

Brake Diameter: 16-1/2 in.  
Fit: Meritor Q & Q+ with Bolt-On Bushing

### Pro-Par





## Cam Repair Kits

AXL

Camshafts

### PROWCR1443

Qty	Part Number	Description
2	PROWC8800	Seal
1	PROWC8884	Lock
1	PROWC8817	Bracket
1	PROWC8835	Washer
4	PROWC8850	Screw



Brake Diameter: 16-1/2 in.  
Fit: Meritor Q & Q+ with Press-In Bushing

Pro-Par

### PROWCR1444

Qty	Part Number	Description
1	PROWC8811L	LH Bracket Assy
1	PROWC8812R	RH Bracket Assy
2	PROWC8841	Lock Ring
2	PROWC8884	Lock Ring
2	PROWC8847	Lock Ring
2	PROWC8857	Spider Bushing
2	PROWC8855	Washer
2	PROWC8880	Washer
2	PROWC8856	Washer
2	PROWC8831	Washer
2	PROWC8829	Washer
8	PROWC8898	Self Tapping Screw
4	PROWC8800	Spider Seal



Brake Diameter: 12-1/4 in. & 16-1/2 in.  
Fit: Spicer Standard & XL Brakes

Pro-Par

### PROWCR1445

Qty	Part Number	Description
1	PROWC8811L	LH Bracket Assy
1	PROWC8812R	RH Bracket Assy
2	PROWC8841	Lock Ring
2	PROWC8847	Lock Ring
2	PROWC8854	Spider Bushing
2	PROWC8824	Washer
2	PROWC8826	Washer
2	PROWC8830	Washer
2	PROWC8880	Washer
2	PROWC8831	Washer
2	PROWC8833	Washer
8	PROWC8898	Self Tapping Screw
4	PROWC8822	Seal



Brake Diameter: 12-1/4 in. & 16-1/2 in.  
Fit: Spicer Standard & XL Brakes

Pro-Par

## Cam Repair Kits

### Tube Kit

**PROWCR1448-1**



Qty	Description
1	Tube
4	Bolt
4	Nut
2	Snap Ring
6	Washer
2	Bracket



Brake Diameter: 16-1/2 in. & 17 in.  
Fit: Hendrickson, Cam Tube, New Bracket

Pro-Par

### SIRB8684A

Qty	Description
1	Lock Ring
2	Lock
1	Bushing
2	Seal
4	Washer
1	Bushing



Brake Diameter: 16-1/2 in.  
Fit: Eaton ES

Sirco

### SIRB8773MA

Qty	Description
1	Bracket
1	Retainer Assy
2	Lock Ring
1	Lock
3	Seal
4	Washer



Brake Diameter: 16-1/2 in.  
Fit: Meritor Q & Q+ with Bolt-On Bushing

Sirco

## Cam Brackets

### Cam Tube / Chamber Bracket

Location	Part Number
Left Hand	<b>DAN977196</b>
Right Hand	<b>DAN977197</b>

Bendix



Dana RS/RF Suspensions

Location	Part Number
Left Hand	<b>DANM16WHR50H-L</b>
Right Hand	<b>DANM16WHR50H-R</b>

Bendix



AXL

Camshafts



## Cam Brackets

**FRUACF4024-900**

**Fruehauf**  
Pro-Par Axle - Kit

**Camshaft Support Bracket & Bushing**  
**MTRA-3299T5844**

**Meritor**

xRef	Location	
Euclid E11445	Left Hand	<b>PROWC8811L</b>
Euclid E11446	Right Hand	<b>PROWC8812R</b>

**Pro-Par**  
Qty: 2 per box

**PROWC8696**

**Pro-Par**  
Fit: Meritor  
xRef: Euclid E1318A

**Heavy Duty**  
**PROWC8696HD**

**Pro-Par**  
Fit: Meritor  
xRef: Euclid E1318AHD

**PROWC8714**

**Pro-Par**  
Brake Diameter: 16-1/2 in. xRef: Euclid E2104  
Fit: Standard Forge & Spicer

**PROWC8717**

**Pro-Par**  
Fit: Std Forge & Spicer xRef: Euclid E2365  
For PROWC8714 bracket assembly

AXL

Camshafts



**Cam Bushings**

**AXL**

**Camshafts**

**FRUACD2285-900**



Fruehauf  
Pro-Par Axle

**MTRR657003**



Meritor  
Material: Nylon  
Length: 7/8 in.

Inner Diameter: 1-5/8 in.  
Outer Diameter: 2.00 in.

**PROWC8805**



Pro-Par  
Material: Nylon  
Length: 7/8 in.

I.D.: 1-5/8 in. O.D.: 2.00 in.  
xRef: Euclid E1567

**PROWC8819**



Pro-Par  
Material: Nylon  
Length: 1-1/4 in.

I.D.: 1-1/2 in. O.D.: 1-7/8 in.  
xRef: Euclid E536

**PROWC8851**



Pro-Par  
Material: Nylon  
Length: 1-1/2 in.

I.D.: 1-1/2 in. O.D.: 1-7/8 in.  
xRef: Euclid E759

**PROWC8853**



Pro-Par  
Material: Nylon  
Length: 1-3/4 in.

I.D.: 1-1/2 in. O.D.: 2-15/32 in.  
xRef: Euclid E2102

**PROWC8854**



Pro-Par  
Material: Bronze  
Length: 1-1/2 in.

I.D.: 1-1/2 in. O.D.: 1-7/8 in.  
xRef: Euclid E807

**PROWC8857**



Pro-Par  
Material: Bronze  
Length: 1-1/2 in.

I.D.: 1-5/8 in. O.D.: 2.00 in.  
xRef: Euclid E9789



## Cam Seals

	Thickness	Inner Diameter	Outer Diameter	xRef
<b>PROWC8800</b>	0.250 in.	1-5/8 in.	2 in.	Euclid E2405
<b>PROWC8810</b>	0.188 in.	1-1/2 in.	2in.	Euclid E2717
<b>PROWC8820</b>	0.250 in.	1-1/2 in.	2-1/16 in.	Euclid E654
<b>PROWC8822A</b>	0.250 in.	1-1/2 in.	1-7/8 in.	Euclid E1416A



(PROWC8800)



(PROWC8810)



(PROWC8820)



(PROWC8822A)

Pro-Par

## Snap Rings

	Thickness	Inner Diameter	xRef
<b>PROWC8847</b>	0.063 in.	1-1/8 in.	Euclid E801
<b>PROWC8841</b>	0.063 in.	1-31/64 in.	Euclid E526
<b>PROWC8843</b>	0.063 in.	1-1/2 in.	Euclid E1569



(PROWC8847)



(PROWC8841)



(PROWC8843)

Pro-Par

## Cam Washers

	Thickness	Inner Diameter	Outer Diameter	xRef
<b>PROWC8823</b>	0.032 in.	1-17/32 in.	2-1/4 in.	Euclid E581
<b>PROWC8824</b>	0.060 in.	1-17/32 in.	2-1/4 in.	Euclid E580
<b>PROWC8826</b>	0.120 in.	1-9/16 in.	2-7/16 in.	Euclid E719
<b>PROWC8827</b>	0.060 in.	1-17/64 in.	1-7/8 in.	Euclid E1113
<b>PROWC8828</b>	0.060 in.	1-41/64 in.	2-3/8 in.	Euclid E1565
<b>PROWC8831</b>	0.0625 in.	1-5/8 in.	2-1/4 in.	Euclid E2411A
<b>PROWC8834</b>	0.0312 in.	1-1/4 in.	1-7/8 in.	Euclid E5095
<b>PROWC8837</b>	0.0312 in.	1-5/8 in.	2-1/4 in.	Euclid E9074
<b>PROWC8880</b>	0.063 in.	1-1/4 in.	2-1/4 in.	Euclid E5137
<b>PROWC8886</b>	0.344 in.	1-41/64 in.	2-3/8 in.	Euclid E9075



Pro-Par

## Automatic Slack Adjusters

AXL

Slack Adjusters

	Spline	Arm Length	Type
<b>BENK043197</b>	1-1/2 in. - 28	5-1/2 in.	Straight
<b>BEN065175</b>		6 in.	Straight



(BENK043197)



(BEN065175)

**Bendix**

	Spline	Arm Length	Type
<b>GUNAS1136</b>	1-1/4 in. - 10	5-1/2 in.	
<b>GUNAS1132</b>		5-1/2 in.	Straight
<b>GUNAS1168</b>	1-1/2 in. - 10	5-1/2 in.	
<b>GUNAS1133</b>		6 in.	
<b>GUNAS1140</b>	1-1/2 in. - 28	5-1/2 in.	Straight
<b>GUNAS1149</b>		5-1/2 in.	
<b>GUNAS1172</b>		5-1/2 in.	Straight
<b>GUNAS1141</b>		6 in.	
<b>GUNAS1150</b>		6 in.	Straight
<b>GUNAS1173</b>		6 in.	
<b>GUNAS1144</b>		1-1/2 in. - 37	6 in.



(GUNAS1136)



(GUNAS1132)



(GUNAS1168)



(GUNAS1133)



(GUNAS1140)



(GUNAS1149)



(GUNAS1172)



(GUNAS1141)



(GUNAS1150)



(GUNAS1173)



(GUNAS1144)

**Gunite/Accuride**





## Automatic Slack Adjusters

	Spline	Arm Length	Application	Bracket Type	Additional
<b>HDX400-10071</b>		5-1/2 in.	Steer Axle	Strap	
<b>HDX400-10155</b>	1-1/2 in. - 10	5-1/2 in.	Drive Kenworth	Strap	
<b>HDX400-10143</b>		5-1/2 in., 6-1/2 in.	Std. Drive Axle	Strap	
<b>HDX400-10211</b>		5-1/2 in.	Trailer Axle	Plate & Flat Stud	Straight; 16-1/2 in. Brake
<b>HDX400-10238</b>		5-1/2 in.		Strap	Straight
<b>HDX400-20211</b>		5-1/2 in.	S-ABA	Plate & Flat Stud	Straight
<b>HDX400-20241</b>		5-1/2 in.	S-ABA	Strap	
<b>HDX400-10141</b>	1-1/2 in. - 28	5-1/2 in., 6-1/2 in.	Std. Drive Axle	Strap	Single Bend
<b>HDX400-10144</b>		6 in.	Drive Mack	Clamp	
<b>HDX400-10212</b>		6 in.	Trailer Axle	Plate & Flat Stud	Straight; 16-1/2 in. Brake
<b>HDX400-10305</b>		6 in.	Trailer Axle	Plate & Flat Stud	Straight; 16-1/2 in. Brake
<b>HDX400-20212</b>		6 in.	S-ABA	Plate & Flat Stud	Straight
<b>HDX400-10213</b>	1-5/8 in. - 37	5-1/2 in.	Trailer Axle	Plate & Flat Stud	Straight; 16-1/2 in. Brake



Haldex

### More Information

#### Haldex Slacks - S-ABA

S-ABA is a self-setting automatic brake adjuster which allows the control arm to be set at any angle from -16 to 130 degrees.

## Automatic Slack Adjusters

AXL

Slack Adjusters

	Spline	Arm Length	Type
<b>RNGRB-21103</b>	1-1/2 in. - 10	5 in., 6 in.	Straight
<b>RNGRB-22103</b>	1-1/2 in. - 28	5 in., 6 in.	Straight



Ranger Brake

(RNGRB-21103)

	Spline	Arm Length	Type	Chamber Size	Additional
<b>MTRR803106</b>	1-1/2 in. - 10	6 in.	Trailer Axle	30	Stroke Sensing
<b>MTRR801073</b>		5-1/2 in.	3	24, 30	Straight, Stroke Sensing
<b>MTRR803049</b>		5-1/2 in.		24	Stroke Sensing
<b>MTRR803110</b>		5-1/2 in.		24	Stroke Sensing
<b>MTRR806019</b>	1-1/2 in. - 28	5-1/2 in.	Trailer Axle		Straight; Clearance Sensing; 16-1/2 in. Brake; Double Bend
<b>MTRR801074</b>		6 in.		30	Straight; Stroke Sensing
<b>MTRR803112</b>		6 in.		30	Stroke Sensing
<b>MTRR803116</b>	1-5/8 in. - 37	6 in.	Trailer Axle	30	Stroke Sensing



(MTRR803106)



(MTRR801073)



(MTRR803049)



(MTRR803110)



(MTRR806019)



(MTRR801074)



(MTRR803112)



(MTRR803116)

### Meritor

## More Information

### Meritor Slacks - Unhanded v.s Handed



"Handed" slacks have pawl assemblies on the main body of the slack to fit a particular side of the axle and aid in clearance with other axle components. "Unhanded" slacks are ones in which the pawl assembly has been moved to the edge of the slack to eliminate having to stock pairs of slacks.

Type 1 = Left Handed    Type 2 = Right Handed    Type 3 = Unhanded

RANGER Brake Products



## Automatic Slack Adjusters

	Spline	Arm Length	Type	Bracket Type	Additional
<b>PROSA56142</b>		5 in., 6 in.	Drive Axle	Strap	
<b>PROSA56215</b>	1-1/2 in. - 10	5-1/2 in.	Trailer Axle	Plate & Flat Stud	16-1/2 in. Brake
<b>PROSA56143</b>		5-1/2 in., 6-1/2 in.	Drive Axle	Strap	
<b>PROSA56216</b>		6 in.	Trailer Axle	Plate & Flat Stud	16-1/2 in. Brake
<b>PROSA56140</b>		5 in., 6 in.	Drive Axle	Strap	
<b>PROSA55073</b>		5-1/2 in.	Unhanded		Chamber Size: 24, 30
<b>PROSA56211</b>		5-1/2 in.	Trailer Axle	Plate & Flat Stud	16-1/2 in. Brake
<b>PROSA56141</b>	1-1/2 in. - 28	5-1/2 in., 6-1/2 in.	Drive Axle	Strap	
<b>PROSA56074</b>		6 in.	Unhanded		Chamber Size: 30
<b>PROSA56144</b>		6 in.	Drive Mack	Clamp	
<b>PROSA56175</b>		6 in.	Curved		
<b>PROSA56212</b>		6 in.	Trailer Axle	Plate & Flat Stud	16-1/2 in. Brake
<b>PROSA56214</b>	1-5/8 in. - 37	6 in.	Trailer Axle	Plate & Flat Stud	16-1/2 in. Brake



(PROSA56215)



(PROSA55073)



(PROSA56211)

Pro-Par

AXL

Slack Adjusters

## There is a Difference | SLACK ADJUSTERS

### RANGER BRAKE



### TROUBLE-FREE PERFORMANCE

*DOESN'T JUST FALL FROM THE SKY.  
IT'S BUILT FROM THE GROUND UP.*

Our slacks are designed by RANGER BRAKE to equal the OE/Original Equipment units, and to improve on their weaknesses...

to **GUARANTEE CUSTOMER SATISFACTION.**  
We test every single slack, with Ranger hands in Alexandria TN, U.S.A - using our

#### Aggressive 10-Pt DYNAMIC Test Procedure

1. S-CAM Fitment
2. CW / CCW Rotational Torque and Ratchet Response at Hex
3. Adjustment-Arm Available Movement
4. Hex Nut Rotation in Degrees Relative to Adjust-Arm Movement
5. S-CAM GEAR Movement in Degrees Relative to Adjust-Arm Movement
6. CLUTCH Pressure Setting and Plate Force OUTPUT
7. Degree of Hex Rotation Required for CLUTCH to Engage Relative to Adjust-Arm Movement
8. Degree of Hex Rotation Required for CLUTCH to Dis-Engage Relative to Adjust-Arm Movement
9. CLEVIS Assembly Inspection of Threads, Fitment, and Yoke Hole Location
10. VERIFY Template Form and Fit



**pro-par**  
OE & Heavy Duty Parts  
**HALDEX** Style

Also Available:

Meritor Style

Gunite Style

Bendix Style

Crewson Style



## Automatic Slack Adjusters

AXL

Slack Adjusters

	Spline	Arm Length	Type	Additional
<b>STEMK21103S</b>	1-1/2 in. - 10	5 in., 6 in.	Straight	
<b>STEMK41100S</b>		5-1/2 in.	Straight	
<b>STEMK22103S</b>	1-1/2 in. - 28	5 in., 6 in.	Straight	
<b>STEMK22153S</b>		5 in., 6 in.	Curved	ABA
<b>STEMK42100S</b>		5-1/2 in.	Straight	
<b>STEMK42700S</b>		5-1/2 in.	Straight EXT.	
<b>STEMK22102S</b>		5-1/2 in., 6-1/2 in.	Straight	
<b>STEMK42106S</b>		6 in.	Straight	



(STEMK21103S)



(STEMK41100S)



(STEMK22103S)



(STEMK22153S)



(STEMK42100S)



(STEMK42700S)



(STEMK22102S)



(STEMK42106S)

Stemco

## Manual Slack Adjusters

	Spline	Arm Length	Type
<b>IMXGT-5800</b>	1-1/2 in. - 10	5 in., 6 in., 7 in.	Straight
<b>IMXGT-5804</b>		5-1/2 in., 6-1/2 in.	Straight
<b>IMXGT-5801</b>	1-1/2 in. - 28	5 in., 6 in., 7 in.	Straight
<b>IMXGT-5803</b>		5-1/2 in., 6-1/2 in.	Straight
<b>IMXGT-5802</b>		1-5/8 in. - 37	5 in., 6 in., 7 in.



(IMXGT-5800)



(IMXGT-5804)



(IMXGT-5801)



(IMXGT-5803)



(IMXGT-5802)

Economy

STEMCO



**Slack Adjuster Accessories**

**Angled Strap Drive Bracket**  
HDX427-10553



**Plate & Stud Standard Bracket**  
HDX427-10563



**Trailer Slack Adjuster Bracket**  
HDX427-10565



**Stud Kit**  
HDX427-10558



**Flat Stud Nut**  
HDX443-10204



**Double Flat Stud**  
HDX443-10290



**Bushing**  
HDX452-10125



**ASA Bushing**  
MTRR002307



AXL

Slack Adjusters

Haldex

MERITOR

**Slack Adjuster Accessories**

AXL

Slack Adjusters

**Lock Pawl**  
**MTRR801700**

Meritor



**More Information**

**Slack Adjusters**



**Bendix Style**



**Gunite Style**



**Haldex Style**



**Meritor Style**



**Stemco Style**

Meritor, Gunite, Bendix, and Stemco style are stroke sensing slack adjusters. This means that they will make an adjustment on the brake application. Haldex style slack adjusters are clearance sensing and will recognize the difference between the lining and the drum on the way back.

